

THE

iX



#bornelectric



CHANGE

CAN SOMETIMES SEEM
LIKE A CHALLENGE.



That's why at BMW i,
we believe in overcoming obstacles.

We have been pioneering electric
mobility for the past ten years,
and we will continue to be
at the forefront of positive change
in the future too. To do that,
we want to discuss our ideas with you.
We want to embrace change together.

Because we believe
in the endless possibilities
of shaping the future and we believe
there are plenty of great reasons
to take that next step.

Let's take it together.
Let's make the future we want to live in
become reality.

LET'S MAKE CHANGE
HAPPEN.



CONTENTS

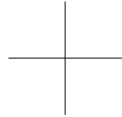

Let's make change happen 02

Key Facts 06

ELECTRIC DRIVING PLEASURE

Agility, comfort and efficiency 08

Range 12

intelligent lightweight construction & aerodynamics 14

Editorial: Extreme electromobility 16



BMW CHARGING

BMW Charging offers 18



Fascinating, different, electric: driving pleasure rediscovered.

Intelligent technology that creates connections – between people, the vehicle and the world.

CONNECTIVITY

Connectivity 20

Driver assistance 24

DESIGN



Exterior design 26

Exterior worlds 34

Editorial: Shy Technology exterior and interior 36

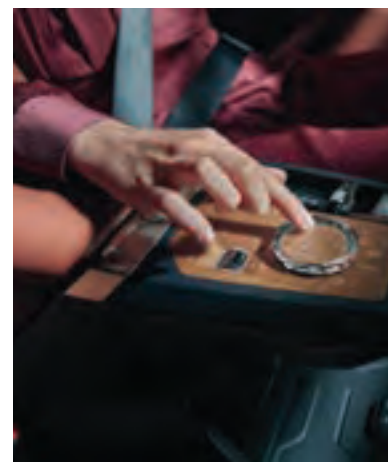

Interior design 38

Interior worlds 44

Designed from the inside to the outside, interior and exterior harmonise to become a true living space.



SUSTAINABILITY

Editorial: Think about the end from the start 46

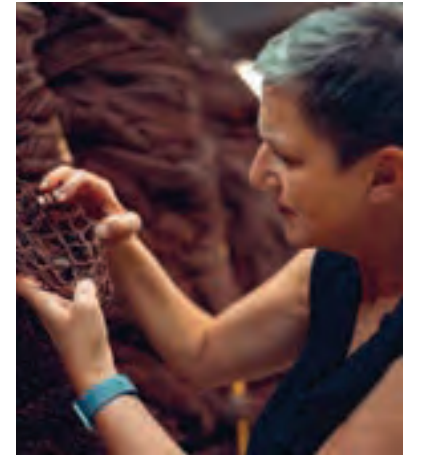

Consume little, achieve everything: Sustainability 48

The material cycle of a battery cell 50

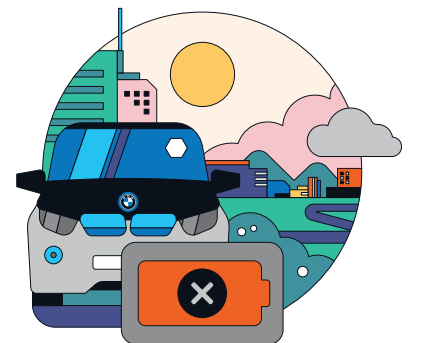

Editorial: The bees of Dingolfing 52

Technical values 54

RANGE OF UP TO
425 KM¹
(WLTP)

THE FIRST FULLY-ELECTRIC
ALL-WHEEL SAV FROM BMW

“The BMW iX combines the best
proportional attributes of the X-family:

larger interior than the X5,
the dynamic roof line of an X6
and the large wheels of an X7”.

Domagoj Dukec – BMW Design Head

RECHARGE THE RANGE
UP TO 95 KM IN **10**
MINUTES^{1, 2, 3, 4}

Partially-automated
driving

LOUNGE ATMOSPHERE

0 TO 100 KM/H
IN **6.1** SEC

INTELLIGENT SHY TECH

20%
RECYCLED
PLASTIC

INTERIOR MADE
OF SUSTAINABLE
MATERIALS

19.4–22.5 KWH
POWER CONSUMPTION
FOR 100 KM (WLTP)

240 KW
(326 HP) OUTPUT

PRODUCED
USING 100%
RENEWABLE
ENERGY

¹ Range depends on various factors, in particular: individual driving style, route characteristics, outside temperature, heating/air conditioning, pre-conditioning.
² The combined electrical consumption depends on the selected wheel and tyre sizes.
³ Dependent on the local electricity infrastructure. Charging time AC is based on charging power of 11 kW, charging time DC is based on charging power of up to 150 kW for xDrive40.
⁴ Values refer to an initial load status of 10%.

ELECTRIC EUPHORIA LIKE NEVER BEFORE.

Pure driving pleasure every second, for up to 425 km^{1,2} with one charge: In the new BMW iX xDrive40, you get a whole new kind of driving experience, designed from the ground up electrically. Uniquely nimble, the new BMW iX, available in

several vehicle types, accelerates from 0 to 100 km/h¹ in 6.1 seconds and is inimitably responsive and highly agile. Thanks to the high-performance electric motor duo, delivering 240 kW (326 hp) and a highly efficient consumption³ of 19.4-22.5 kWh/100 km¹,

its all-wheel drive has ample power reserves at all times for exciting sprints and memorable long-distance journeys. Combined with the virtues of a spacious SAV-like interior and raised seating position, the new BMW iX conveys a feeling of

grandeur and progressiveness. Welcome to the future – now.

Four driven wheels,
two electric motors, one result:
electric driving pleasure like you
have never experienced before.



¹ Values apply for the BMW iX xDrive40

² Range depends on various factors, in particular: individual driving style, route characteristics, outside temperature, heating/air conditioning, pre-conditioning.

³ The combined electrical consumption depends on the selected wheel and tyre sizes.

FIRST FULLY ELECTRICAL BMW WITH ALL-WHEEL DRIVE – THE NEW BMW iX.

Power, traction, efficiency - but above all one thing: absolute euphoria, again and again: With a drive system from the latest BMW eDrive generation, you experience maximum driving pleasure in the first fully electric BMW with all-wheel drive.

■ The new BMW iX features extremely agile and comfortable handling, coupled with the seating position typical to the X and a spacious feel. Its dynamic configuration is underscored by supreme body strength, balanced weight distribution, and a low centre of gravity. Together with its large wheels, the new BMW iX has now dramatically reduced any rocking while delivering the kind of agility that means that the next endorphin rush is just around the corner: the sheer emotional driving pleasure in the new BMW iX really know no bounds.



iX xDrive40	200 TOP SPEED ⁴ (KM/H)	425–372 ELECTR. RANGE (WLTP) ¹ ; MAX. (KM) ³	240 (326) SYSTEM OUTPUT (KW (HP))
	6.1 DRIVING PERFORMANCE 0-100 KM/H (S)	19.4–22.5 ELECTR. CONSUMPTION COMB. (KWH/100 KM) ²	

■ Configurable recuperation behaviour allows for an individual driving style – here you decide whether you want to recuperate maximum energy by means of one-pedal feeling (gear position B) with as few accelerator pedal changes as possible or whether you prefer customised vehicle deceleration (gear position D). This adaptive recuperation offers a direct and convenient way of exploring the exciting new world of electric vehicles. In any case, with the superior power and high efficiency of the innovative electric motor duo, almost any destination can be reached at any time with ease and a great deal of pleasure in electric driving.

RECUPERATION OPTIONS AT A GLANCE:

Gear position B: A fixed maximum recuperation level delivers a no-holds-barred one-pedal feeling until you come to a standstill, all this without creeping.

Gear position D: Recuperation here is adaptive, and can be configured by the driver using four settings (adaptive, high, medium, low). This allows you to slowly roll forward until you come to a standstill.

■ Standard equipment □ Optional equipment

¹ Official data for power consumption and range were determined in accordance with the measuring procedures as defined by European Regulation (EU) 715/2007 in the applicable version and comply with same. In the event of ranges, data determined as per WLTP takes into account any optional equipment (available on the German market in this case). For vehicles that have been newly type approved since 1 January 2021, only the official data according to WLTP exist. For more information about NEDC and WLTP measuring procedures visit www.bmw.in/wltp

² The combined power consumption depends on the selected wheel and tyre sizes.

³ Range depends on various factors, in particular: individual driving style, route characteristics, outside temperature, heating/air conditioning, pre-conditioning.

⁴ Electronically limited.

The availability of some equipment features and functions depends on engine variants or additional options. The market and production availability may vary. You can find detailed information about terms, standard and optional equipment at www.bmw.in or at your BMW Partner.

IN ITS ELEMENT WHATEVER THE DISTANCE –
THE RANGE OF THE NEW BMW iX.

■ Whether a short trip to town or a longer journey, the new BMW iX does the job with its very low power consumption of 19.4-22.5 kWh/100 km¹. This, coupled with the high battery capacity of over 76 kWh, gives you a range of 425 kilometres (WLTP)^{1,2}, with zero local emissions.

■ In addition, the battery can be charged from 10 to 80% in 31 minutes at high-power charging stations (HPC). As that's what makes electric driving fun: flexible reliability that makes the new BMW iX absolutely suitable for long journeys and fits perfectly into your everyday life.

HIGH PERFORMANCE IN
POWER AND CHARGING.

■ The **lithium-ion high-voltage battery** in the new BMW iX incorporates the entire development expertise of BMW. The latest generation of batteries is characterised by a significant increase in performance and energy density and can optimally display its high-performance characteristics, especially during highly dynamic driving and fast charging. The particularly long-life lithium-ion

high-voltage battery is also placed flat and safely in the vehicle floor. In this location, it ensures a low centre of gravity, which together with the even 50:50 weight distribution across both axles, enhances vehicle agility and provides ample space for passengers and luggage.

iX xDrive40

Up to
425 km
range (WLTP)^{1,2}

Recharge the range
up to 95 km in **10**
minutes^{1,3,4,5}

Fast charge of 10-80% in
just **31 minutes**^{1,3,4} at
a public charging station

■ Standard equipment □ Optional equipment

The availability of some equipment features and functions depends on engine variants or additional options. The market and production availability may vary. You can find detailed information about terms, standard and optional equipment at www.bmw.in or at your BMW Partner.



¹ Values apply for the BMW iX xDrive40.

² The lithium-ion high-voltage battery is characterised by its long service life and a warranty of up to 8 years or 160,000 km, whichever is earlier.

³ Range depends on various factors, in particular: individual driving style, route characteristics, outside temperature, heating/air conditioning, pre-conditioning.

⁴ Dependent on the local electricity infrastructure.

⁵ Values refer to an initial load status of 10%.

MODERN, STABLE AND WELL THOUGHT-OUT -
LIGHTWEIGHT CONSTRUCTION IN THE NEW BMW iX.

Form follows function: The new BMW iX follows this legendary design principle in every detail – with the aim of combining maximum range, efficiency and dynamics to create a unique driving experience. Aerodynamic refinements catch the eye even at first glance, such as the exterior mirrors integrated into the window well strips, flush embedded door handles, and lightweight Air Performance light-alloy wheels; even the concealed underbody has a flat, smooth design. Here everything is designed to glide through the air flowing past with the least resistance – with success: the new BMW iX achieves a sensational drag coefficient of $c_w = 0.25$. You can even see these aerodynamics: vertical air curtains in the front apron guide the air flow to the wheels with the minimum of resistance, while the black streamflow sections in the D-pillar, characteristic of the BMW i, symbolise the optimised air flow around the passenger compartment.

The fascination grows by the second: completely frameless doors, slim profiles and the silhouette with visible carbon structure in the entry and tailgate sections showcase the weight-optimised material mix of the body. Aluminium, carbon and high-strength steels are each used where they contribute to a reduction in weight, an improvement in the interior feel and handling as well as a greater range – and thus to an experience that can be enjoyed again and again with the greatest pleasure thanks to intelligent lightweight construction.



- The reduced styling draws attention to precisely designed details that emphasise the high-quality character and optimised aerodynamic characteristics of the new BMW iX.



and the power electronics must prove its worth. This is just one of the tests in the so-called hot-climate test, which is part of the comprehensive development and test program of the series development. In both the winter and heat tests, the prototypes are subjected to the stresses and strains of a complete vehicle life practically in fast motion.

heated in the sun and then cooled down. The developers not only test the operability of the electrical systems, but also the temperature resistance of the materials in the interior. Nothing must creak or crackle here – neither at high nor low temperatures. The dustproofness of bonnets, doors and flaps is also extensively tested in the desert. When driving thousands of kilometres through dunes, savannahs and bush land, a new BMW may kick up a lot of dust – but it must not let any of it get inside.

In extreme plus and minus temperatures, driving on ice, snow, desert sand and gravel, experienced BMW engineers use powerful measuring technology on board to register all the vehicle's responses to a wide range of weather conditions, road surfaces and other influences. At temperatures that would cause any mobile phone battery to discharge in no time at all, the powerful integrated cooling concept of the high-voltage battery proves its worth. The drive and chassis components are also tested and tuned to each other under extreme conditions. For hours, a new pre-series model is repeatedly

► Icy cold, shimmering heat: Before series launch, BMW tests its electric vehicles under the toughest conditions on the Arctic Circle in Sweden and in the South African Kalahari Desert to ensure optimum range and performance.

Arjeplog, 56 kilometres south of the Arctic Circle. –26 °C. Barely bright, daylight disappears again on the grey horizon just a few hours later. A lonely place. Suddenly dry powder snow flies up. A new electric BMW prototype accelerates at high speed around the bend and over the snow-smooth road surface, which can only be assumed to be a road. Welcome to the BMW winter tests in the icy wasteland of Lapland, in the north of Sweden. Here, every BMW has to prove that it functions perfectly even under extreme conditions.

The new electric BMW model rushes across the mirror-smooth ice surface of a kilometre-long lake, brake lights come on, a short swerve, the vehicle comes to a halt – to start again immediately, to accelerate, to brake. These are ideal conditions for testing all the components of the BMW eDrive technology in detail, because its components make special demands from BMW engineers: For example, the electrochemical processes within the high-voltage battery run differently depending on the ambient temperature – a fact that is being examined in great detail here to ensure the highest possible performance and reliability in the production vehicle.

Change of scenery. Kalahari, Southern Africa. Unpaved sand, gravel and scree tracks. Extreme heat and solar radiation. Permanent dust formation. At the highest temperatures, the integrated cooling concept for the lithium-ion battery, the electric motor

► In the desert region in the northwest of South Africa, the drive and chassis components can be tested and tuned to each other under extreme conditions.



+

EXTREME
ELECTRO-
MOBILITY.

CONVENIENCE KNOWS NO BOUNDARIES: MORE OFFERS BY BMW CHARGING.

Enhance your charging equipment with customised BMW Charging solutions. For instance, with a Wallbox to charge your vehicle from home even more conveniently. Our installation service will be happy

to connect and install it at home for you. The options are almost endless – with BMW Charging you can experience the fully fledged variety of modern mobility.

BMW WALLBOX FOR FAST AND CONVENIENT CHARGING AT HOME.

■ The BMW Wallbox¹ offers you safe, stress-free and convenient charging. With the permanently installed robust and outdoor-ready BMW Wallbox, you

can charge your new BMW iX quickly and reliably with currently up to 11 kW (3-phase). In addition to its compact dimensions in typical BMW design, the BMW wallbox also offers convenient cable management including plug and wall mount. Thanks to

the integrated residual current detection and a service app, installation is simple and cost-effective - you can book this service for the BMW Wallbox right away.



AT HOME EVERYWHERE – FLEXIBLE AND MOBILE CHARGING WITH THE FLEXIBLE FAST CHARGER..

□ The optional **Flexible Fast Charger** offers maximum flexibility when charging at home. The fast charger always adapts to the charging infrastructure thanks to the available cable adapters and can be connected to both domestic and industrial plug sockets. You can take the compact, light Flexible Fast Charger with you wherever you go and also charge your BMW in another "home", for example a second or holiday home.

Flexible charging
with up to
11 kW
power



SMART WALLBOX.

□ Even smarter charging at home: in addition to a charging power up to 22 kW the Smart Wallbox¹ offers our partners comprehensive connectivity. This makes smart, additional services for intelligent charging possible. For instance, the Smart Wallbox can be integrated into an existing home energy management system and conveniently controlled online.



■ Standard equipment □ Optional equipment

¹ Equipment available as an option from Original BMW i Accessories.



EUPHORIA THRIVES ON INNOVATION.

Explore a whole new world, but keep in touch with what makes you feel good: In unique combination with the digital design, the new BMW iX provides the most emotional, personalised, and comfortable driving experience ever in a fully electric BMW. Experience high tech, perfectly tailored to your needs and always state-of-the-art. Digital intelligence to

make any journey safer and more enjoyable. A distinctive intuitive design aimed squarely at the driver's needs. Discover that special connection, both with and in your new BMW iX.

■ The next generation **BMW iDrive** takes the relationship between you and the new BMW iX to another level. Even as you approach the vehicle, the new system neatly bridges the gap between analogue and digital technology with the "Great Entrance Moments" feature. This allows the new **BMW Operating System 8** in the vehicle to open a personal and proactive dialogue between you and the new BMW iX, and broadens the horizons of your driving experience.

■ Never before has the connection between driver and vehicle been more direct and intuitive. The operating concept follows the holistic philosophy of providing any function and information as easily and conveniently as possible. Plain language as well as touch and gesture control are the top priorities. Physical buttons have been pared down to a relevant selection and are clustered in an innovative control centre in the free-standing centre console. The new BMW Operating System 8 creates a whole new overall experience in the vehicle, tailored to your specific needs by allowing you to individually configure and immediately show your favourite content in all relevant display fields of the Control Display.

■ Standard equipment □ Optional equipment

The availability of some equipment features and functions depends on engine variants or additional options. The market and production availability may vary. You can find detailed information about terms, standard and optional equipment at www.bmw.in or at your BMW Partner.



Technology becomes useful when it makes our everyday life more pleasant, more convenient and better – or, best of all, everything at once.

■ If the BMW Operating System 8 is the beating heart of any encounter with the new BMW iX, the **BMW Virtual Assistant*** is its soul. On call for you at any time, a simple "Hey BMW" or your chosen activation word is enough to open the assistant – no need for buttons! It controls the climate, plays music, or comes to your aid as a reliable expert providing invaluable information on the BMW iX. The BMW Virtual Assistant proactively helps to automate repetitive tasks and explain unused vehicle features. In this way, any interaction with the new BMW iX becomes the kind of special experience you'll want every time.



■ Setting the stage for an amazing experience: **BMW Live Cockpit Professional** has everything you need for a complete, and completely new, user experience: an intuitive, natural interaction between you and your new BMW iX. The sweeping combination of a 12.3" instrument cluster and the 14.9" Central Information Display seems to float almost freely above the extensive instrument panel, and blends harmoniously into the neatly structured interior. All functions and information are then made available just when and how you need them, making every encounter between you and the new BMW iX even more enjoyable, more human, and more unforgettable still.

■ Standard equipment □ Optional equipment

*The availability of some equipment features and functions depends on engine variants or additional options. The market and production availability may vary. You can find detailed information about terms, standard and optional equipment at www.bmw.in or at your BMW Partner.



■ **Parking Assistant Plus¹** makes even parking the new BMW iX more pleasurable: in addition to the functions of the standard Parking Assistant, cameras in the radiator grille, in the exterior mirrors and in the tailgate make manoeuvring and parking easier.

□ The **Driving Assistant** provides more comfort and safety for monotonous and unclear driving situations: it includes numerous other features to make your journeys even safer and more enjoyable. The **Lane Change Assistant** performs the lane change independently to the desired direction very comfortably after activating the turn signal. The **front crossing traffic warning** supports you in unclear situations, such as narrow driveways or when entering or leaving a parking space when you brake your new BMW iX before difficult-to-see crossing traffic. One particularly clear feature: thanks to **Assisted View**, the operating principle of the individual driver assistance systems can be displayed as a 3D environment in the instrument cluster.

EVERYTHING SAFELY UNDER CONTROL.

Technology precisely optimised for your requirements: the new BMW iX is always at your side, providing reliable support even in challenging driving situations with a wide range of standard driver assistance systems. The extensive safety equipment includes Lane Departure Warning with lane return and Collision Warning with light braking function. In addition, extensive parking functions¹ such as

Reversing Assist Camera with Panorama View, Reversing Assistant and a Park Assist for parallel, perpendicular and confined parking bays are on-board as standard – everything to make you feel perfectly at home on every trip and able to confidently navigate every situation



■ Standard equipment □ Optional equipment

¹ The driver is responsible for constantly monitoring the automated parking procedure in accordance with local road laws.
² Function may be limited in darkness, fog or bright glare.

* The availability of some equipment features and functions depends on engine variants or additional options. The market and production availability may vary. You can find detailed information about terms, standard and optional equipment at www.bmw.in or at your BMW Partner.

THE EXTERIOR DESIGN OF THE NEW BMW iX.

A stroke, a word, a gesture – really great ideas get rid of the complicated stuff so that what really matters can shine through. The new BMW iX with Sport package is the very embodiment of this ground-breaking approach. Characterised by sculptural and monolithic proportions, their exterior

design immediately draws everyone's attention. Every detail merges with the sculpture, which is drawn by a few lines. The result is an aesthetic that provides a simple answer to the complex question of unforgettable design.



“The BMW iX shows how we can
give new technologies a very
modern and emotional design.”

Adrian van Hooydonk
Head of BMW Group Design



THE FRONT DESIGN OF THE NEW BMW iX.

The face of a new movement: what drives the new BMW iX is more than its engine. Its design alone encapsulates the need to make mobility easier and more comfortable, and its front section, full of character, creates the sort of powerful presence and dynamics rarely seen in a vehicle.

■ Its monolithic and sculptural design principle is already expressed in the front, which has a strong character: at the centre is the vertical double kidney grille, whose closed characteristics signpost the innovative drive, as do accents on the indicated air inlets. A strongly three-dimensional bonnet stretches

over it, flanked by particularly slender headlights – a front view that combines dynamism and powerful presence in an unseen way with a great deal of sensitivity.

■ The front design is particularly fascinatingly modern with the sports package. Closed triangular elements emphasise the confident width of the new BMW iX. The dynamic trapezoidal shape of the central design element additionally underlines the overall sporty effect.



SCULPTURAL BONNET.

■ The sculpturally shaped bonnet surrounds the kidney, seamlessly encloses it at the top and continues it like a turbine underneath – which, in conjunction with the narrow headlights, gives the front end power and dynamism.

MODERN HEADLIGHT DESIGN.

■ The narrowest headlights ever mass-produced by BMW symbolise the digital intelligence of the new BMW iX. The daytime running light has a two-dimensional graphic design and underlines the monolithic design language of the vehicle.

■ Standard equipment □ Optional equipment

The availability of some equipment features and functions depends on engine variants or additional options. The market and production availability may vary. You can find detailed information about terms, standard and optional equipment at www.bmw.in or at your BMW Partner.



THE SIDE DESIGN OF THE NEW BMW iX.

Icon of a new self-confidence: Within clearly defined proportions, tightly modelled surfaces form a powerful vehicle body. A deliberate reduction of character lines and fully integrated flat door openers allow the design language of the new BMW iX to take maximum effect – little, but effective is the principle here.

■ The vehicle body tapers towards the rear, creating an elegant, dynamic silhouette. The wheel arches, on the other hand, are framed by striking rectangular contours, which as a self-confident graphic element

cite the wheel arches of the first BMW X models. In between, an accent strip runs along the vehicle – a magnet for attention that also alludes to the innovative battery technology in the vehicle floor.

□ The sports package makes the athletic character of the new BMW iX even more exciting. Thanks to the high-gloss black painted side skirts and exclusive 21" or 22" rims, the side view is excitingly different and even more dynamic.

DOORS WITH FRAMELESS WINDOWS.

■ For the first time in a BMW X model, the doors are completely frameless. This creates a flush side graphic from the A to the D-pillar, provides maximum support to the new pared-down design, and gives you a fantastic feeling just stepping into the new BMW iX.

INTEGRATED SIDE MIRRORS.

■ For the first time, side mirrors are integrated into the well strip: the mirror base seems to flow from the strip to border the side mirror from below.

ELECTRIC DOOR OPENER.

■ Integrated over the entire surface and inlaid flat: Together with the frameless doors, the new electric door opener create an almost flush side view that is both modern and dynamically elegant. An accent strip around the handle shaft provides a high-quality and exclusive highlight.

■ Standard equipment □ Optional equipment

The availability of some equipment features and functions depends on engine variants or additional options. The market and production availability may vary. You can find detailed information about terms, standard and optional equipment at www.bmw.in or at your BMW Partner.



“The monolithic design with few but clear lines is full of character and makes the vehicle look powerful. The BMW iX is robust yet clean and elegant.”

Domagoj Dukec
BMW Design Head

DESIGN ELEMENTS IN TITANIUM BRONZE.

□ How to draw attention: brackets in Titanium Bronze and folded down are a striking indicator of quality, accentuating the self-assured width of the vehicle when viewed from the rear. Combined with the Sport package, the diffuser insert at the rear gleams in high-gloss sporty Black.

NARROW REAR LIGHTS.

■ The very narrow tail lights are made in one piece and therefore look very modern and clear. They extend far into the rear for maximum width effect. With their modern interpretation of the L-shape and a strongly contoured surface work, they have an unmistakable effect. Especially at night, the graphic lighting of the new BMW iX is a visual experience.



THE REAR DESIGN OF THE NEW BMW iX AND BMW iX WITH SPORT PACKAGE.

■ The striking, dynamic rear end gives the new BMW iX a fitting finish: Without distracting small details, the modelled, generous surface work appears particularly high-quality and expressive.

■ A flared shoulder area emphasises the self-assured stance of the new BMW iX. This effect is further underlined by the single-part rear lamps – the slimmest, most streamlined lamps ever to have been fitted by BMW. The tailgate extends across the entire width of the rear section – without any dividing lines – and gives the monolithic design principle a fascinating appearance.

■ In the rear apron itself, colour-contrasting elements set a visual benchmark for the innovative drive concept of the new BMW iX: design that makes substance visible gives the new BMW iX its unforgettably modern appearance.

■ The sheer pleasure of hitting the road is deeply ingrained in the design DNA of the new BMW iX: with the sports package, the bumper shows a fascinatingly independent geometry. Here, the diffuser elements are painted in body colour and underline the sporty, wide appearance of the rear.

■ Standard equipment □ Optional equipment

The availability of some equipment features and functions depends on engine variants or additional options. The market and production availability may vary.

You can find detailed information about terms, standard and optional equipment at www.bmw.in or at your BMW Partner.

MORE THAN COLOUR: EMOTION.

The exterior trim of the new BMW iX draws all the attention in eight fascinating colours with accents in Titanium Bronze, Black solid high-gloss or BMW i Blue. From classic-elegant

to dynamic-sporty, each nuance highlights another facet of its unique character – for a look that captivates anew at every encounter.

SOLID

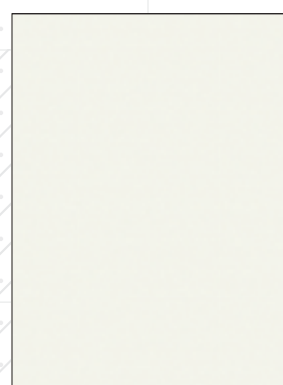

■ Non-metallic 300 Alpine White

METALLIC

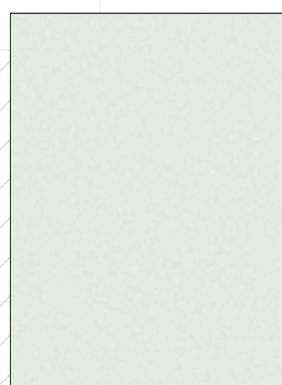

■ Metallic A96 Mineral White¹

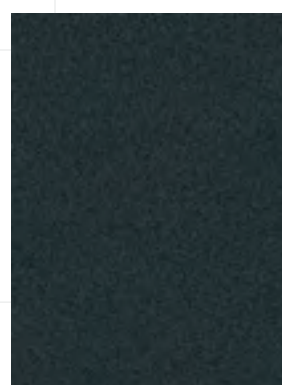

■ Metallic A90 Sophisto Grey Brilliant Effect

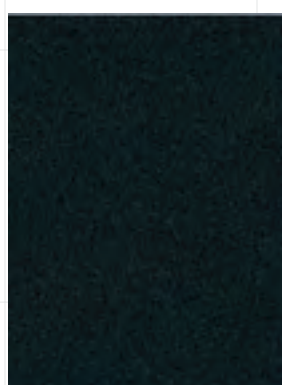

■ Metallic 475 Black Sapphire

BMW INDIVIDUAL



■ Metallic C35 Blue Ridge Mountain



■ Metallic C1M Phytonic Blue



□ BMW Individual C3N Storm Bay metallic¹



□ BMW Individual C57 Aventurine Red metallic¹

■ Standard equipment □ Optional equipment

¹ Only available in conjunction with Sport package.
² Not available in conjunction with Sport package.

[Colour samples] These colour samples are intended as an initial guide to the colours and materials available for your BMW. However, experience

has shown that printed versions of paint, upholstery and interior trim colours cannot in all cases faithfully reproduce the appearance of the original colour. Please discuss your preferred colour choices with your BMW partner or in your dealership. There you can also see original samples and be assisted with special requests.



■ The Sport package includes design applications in Black high-gloss such as the side accent trim strips and door handles.



□ The BMW Individual Exterior Line Titanium Bronze gives the iX a luxurious appearance. In the Sport package, details such as the kidney graphic, lower side window graphic including exterior mirror base, door handles and model badge at the rear are finished in titanium bronze.

The availability of some equipment features and functions depends on engine variants or additional options. The market and production availability may vary. You can find detailed information about terms, standard and optional equipment at www.bmw.in or at your BMW Partner.

SHY TECH

Stylish minimalism meets cutting-edge technology



The new BMW iX combines the most innovative technologies used today in vehicle production. At the same time, it follows a design philosophy that emphasises people and their need for convenience, clarity, and simplicity. How can these needs be reconciled? The answer lies in advanced "Shy Tech" technology, which displays features when needed but otherwise keeps them in the background.

The interaction of high-tech and comfort creates a life-enhancing space, the guiding principle of the designers of the new BMW iX. Inspired by the trend of boutique hotels, the vehicle is designed both inside and out with the needs of the driver and passenger firmly in mind. These needs have also led to the development of completely new solutions for functional elements.

"If you're looking to create a warm, intimate atmosphere, classic buttons, switches, and covers simply look out of place," says Matthias Junghanns, Head of Interior Design BMW i. "The key concept here is Shy Tech, which describes design solutions that only reveal and allow certain technologies in the vehicle to be used when the driver and other occupants actually need them."

Whereas centre consoles in conventional vehicles tend to house a plethora of buttons and switches, a glance at the new BMW iX brings out harmonious surfaces and fascinating lines. Most functions are controlled digitally. A few elegantly designed buttons and switches serve as functional and visual highlights, for Shy Tech doesn't mean you miss out on features, but relies on a harmonious blend of aesthetics and smart functionality to provide them.

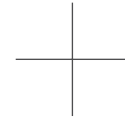

The best example of this is the largest ever Sky Lounge panoramic glass sunroof ever fitted by BMW, featuring electrochromatic tinting. Its glass can be set to clear or opaque at the touch of a button. This means no more headliner, which not only gives the feature a particular elegant look, but also creates more headroom.

This approach of putting the customer's needs first is followed not only in the interior but also extends to the exterior, for example, in the iconic BMW kidney grille. "Because the kidney grille no longer performs a radiator function due to the purely electric drive, it plays the role of an "intelligent surface" in the new BMW iX by seamlessly integrating sensors for assisted driving and defining the self-assured face of the vehicle," explains Dirk Müller-Stolz, Head of Exterior Design BMW i. Even everyday functions show their best side: this is why the flap for refilling the screen wash water is located underneath the BMW emblem on the bonnet. The function here has also been integrated into the design in create a modern sculpture which makes the everyday routine easier for the driver.

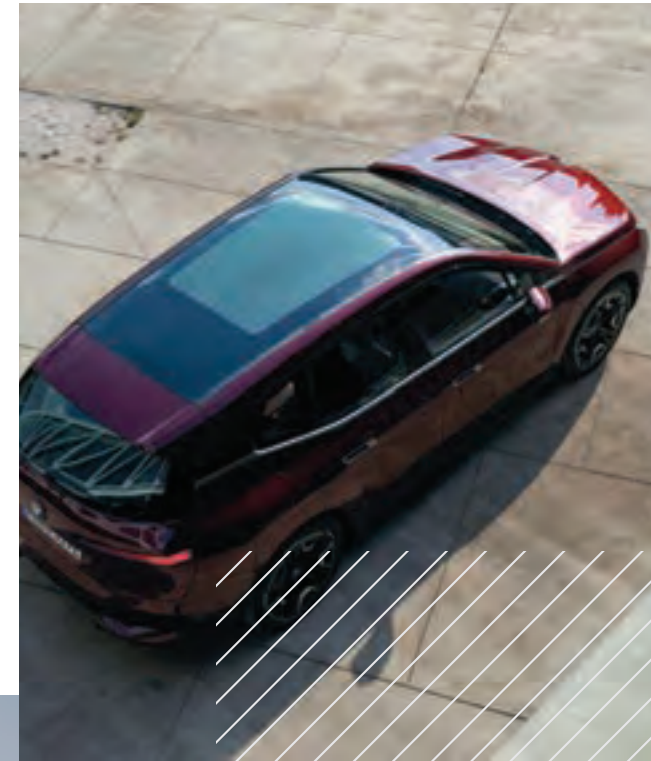

THE INTERIOR DESIGN OF THE NEW BMW iX.

Living space. Favourite place. Playground for the senses. Absolute well-being is the maxim that becomes reality in the new BMW iX through an innovative design philosophy. The inspiration from fine boutique hotels is as tangible as the endeavour to create an oasis of attentiveness and tranquillity in

the midst of everyday life through the generosity of space and surfaces. Selected intelligent functions and intuitive technologies create fascinating design highlights, but otherwise blend discreetly with an interior that makes a clear statement: In this future, you and your needs will be the absolute focus.



+

"We have designed the BMW iX as a mobile space to enhance your quality of life. In other words, a new 'favourite place' in which to relax and feel at ease."

Domagoj Dukec
BMW Design Head

MODERN FEEL-GOOD ATMOSPHERE IN THE NEW BMW iX AND BMW iX WITH SPORT PACKAGE.

The frameless door opens. The fascination begins: from the moment you get in, the new BMW iX conveys a completely new sense of space, inviting you to drive actively and feel at ease. Light floods

the interior through the large panorama glass roof. The result is an ambience inspired by modern boutique hotels.

PANORAMA GLASS ROOF SKY LOUNGE.

■ A vision of light, air and space: The continuous panorama glass roof Sky Lounge floods the interior with sunlight and creates an inviting, friendly atmosphere that combines the interior and exterior. If required, the glass becomes opaque – without a sliding roof lining.

PLENTY OF LEGROOM.

■ Plenty of space - even for the legs: With no central tunnel in the area under the instrument panel, the entire interior not only looks particularly spacious, but also offers plenty of legroom and even a comfortable way to get to the adjacent seat.

SEATS WITH INTEGRATED HEADRESTS.

■ Lean back into a world of comfort and elegance: The highly comfortable seats of the new BMW iX are harmoniously crowned by an integrated headrest which, thanks to a black breakthrough, has a particularly modern and light appearance. In combination with the interior design 'Suite', the breakthrough in the fine colour of gold bronze sets a particularly attractive accent.



LOUNGE-LIKE REAR.

■ Up to three people will find ample space and room on the wide seat. The absence of the central tunnel and a completely flat interior floor create increased legroom, making every journey even more comfortable. The pleasant upholstery with its distinctive diagonal quilting extends all the way to the doors, and the outer seats have integrated headrests - everything for a very special lounge feeling, even in the rear.

■ However, what the designers at BMW have left out has at least as great an effect: With no central tunnel, you are surrounded by a feeling of inviting freedom of movement even in the cockpit, which extends into the lounge-like rear. Buttons and operating elements have been reduced to the bare essentials and fit harmoniously into an interior that radiates peace, security and clarity. Discover your new favourite place: in the new BMW iX.

■ In a design of clear lines and generous-sized surfaces, highlights such as the free-floating centre console, reminiscent of an elegant coffee table, or the virtually free-standing BMW Curved Display catch the eye. Highly comfortable, newly designed seats with slim proportions – and their sustainable materiality further emphasise this ambience.

■ Standard equipment □ Optional equipment

The availability of some equipment features and functions depends on engine variants or additional options. The market and production availability may vary. You can find detailed information about terms, standard and optional equipment at www.bmw.in or at your BMW Partner.

THE COCKPIT OF THE NEW BMW iX.

Inspiringly versatile interpretations for the future: In the new BMW iX, design and technology merge into an experience that is more than the sum of its parts. Even the intuitive interaction with the vehicle via speech, gestures or touch is a source of pleasure. Each control element, concentrated on its essential function, blends seamlessly into the overall concept – or creates wow-effects through a combination of well thought-out function and fascinating form, making every ride unique anew.

■ For example, the frameless BMW Curved Display stands almost free-floating on the slim and flat instrument panel like a work of art in a gallery. Together with the BMW Head-Up Display¹, which is harmoniously and almost invisibly integrated into the dashboard, it forms the visual focus: all information and functions of the new BMW iX flow into the display, orchestrated by the continuously developed BMW iDrive with the intelligent BMW Operating System 8.

■ But highlights such as the iconic steering wheel – the first time in BMW history that it has been designed in hexagonal form – or the innovative control centre in the free-standing centre console also make the principle of intelligent reduction visible and tangible in every detail.



DISPLAY UNIT WITH BMW CURVED DISPLAY.

■ The BMW Curved Display floats almost freely on the spacious instrument panel. Consisting of the 14.9" Central Information Display and the instrument panel in 12.3", the one-piece unit is the next generation of the human-machine interface. The BMW Curved Display fascinates with its information display perfectly designed for the driver and ergonomically optimised, intuitive operation by voice, gesture or touch.

HEXAGONAL STEERING WHEEL.

■ A firm grip on the future: For the first time in the history of BMW, the new BMW iX is steered by a hexagonally shaped steering wheel. The racing-inspired contour of the steering wheel optimises entry and seating comfort as well as the view of the BMW Curved Display, thus visually signalling the start of a new era.

NEWLY DESIGNED GEAR SELECTOR SWITCH.

■ A modern toggle switch replaces the classic gear selector switch and thus consistently follows the idea of intelligent reduction. All important and intelligently arranged control functions on the centre console can thus be operated intuitively and conveniently.

CENTRE CONSOLE CONTROL PANEL.

■ The centre console radiates a genuine feel-good atmosphere. It stands freely between the front seats and spreads the aura of an exquisite piece of furniture. Selected operating elements such as the toggle switch, the central control unit and the audio roller attract attention. The centre console looks particularly elegant in combination with the Clear & Bold equipment: Here your fingers glide gently over the finest open-pored walnut wood and many controls in cut crystal glass.

■ Standard equipment □ Optional equipment

¹ The information in the BMW Head-Up Display is not fully visible when viewed through polarised sunglasses. Content shown will depend on the equipment options chosen. Further optional equipment is required to display specific items.

The availability of some equipment features and functions depends on engine variants or additional options. The market and production availability may vary. You can find detailed information about terms, standard and optional equipment at www.bmw.in or at your BMW Partner.

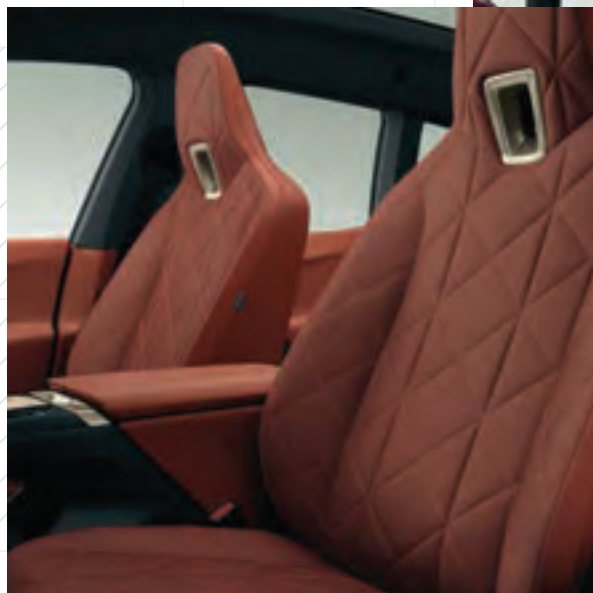

THE INTERIOR DESIGN SUITE.

■ The interior design suite uses the finest olive leaf tanned natural leather in the colours **Castanea** or **Amido** not only on the seats but also on the instrument panel, the door trim panels and the centre console. Accent components and operating elements in elegant Gold Bronze harmoniously round off the luxurious character of this interior design.

■ Standard equipment □ Optional equipment

* The availability of some equipment features and functions depends on engine variants or additional options. The market and production availability may vary. You can find detailed information about terms, standard and optional equipment at www.bmw.in or at your BMW Partner.

Sustainability in focus

THINK ABOUT THE END FROM THE START



Sustainable materials play an ever greater role in BMW interior design. Daniela Bohlinger, Head of Sustainability BMW Group Design, met Giulio Bonazzi, CEO of the Italian company Aquafil, at the site in Ljubljana. The plant produces ECONYL® yarns from recycled fishing nets and other nylon waste.

The fishing nets, which Giulio Bonazzi spreads out across the large table in his conference room, are so clean that you could be forgiven for thinking they were new. "We use a multi-step process to clean the nets and bring them along with other nylon waste to our chemical plant, where they are broken down into their chemical components," explains the Italian yarn manufacturer. The process yields pure ECONYL® nylon granules, which have precisely the same composition as standard crude-oil-based nylon. What's more, once the products manufactured from ECONYL® reach the end of their useful life, they are recycled, regenerated, and processed once more to create new products. "This can be repeated as many times as we like," says Bonazzi. "That is what I call true sustainability."

BMW also uses ECONYL® yarns, for example, to produce material for headliners and floor mats in the BMW i3, the new BMW iX, and other models. For Daniela Bohlinger, Head of Sustainability in Design at BMW, this is the logical consequence of an increased awareness of environmental issues which plays a growing role at BMW. "It was important for us to be able to use a recycled material as a basis for these products. ECONYL® nylon, which is obtained from fishing nets and other nylon waste, has excellent properties for our purposes, comes in a great range of colours, and is popular with designers for its versatility, as it goes without saying that even a product made from recycled material has to look flawless and must have outstanding characteristics."

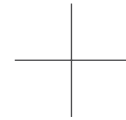

Yet the openness to recycled material displayed by luxury brands still has its limits, says Giulio Bonazzi, though these barriers are beginning to come down. Alongside BMW, examples of companies now using ECONYL® nylon for their collections include Prada and Gucci. Compared with crude oil-derived nylon, production of the recycled material emits 90% less CO₂.

Some of the discarded fishing nets are salvaged from the oceans by divers, "that is the most emotive part of this whole process," says Giulio Bonazzi. "This is the main purpose of The Healthy Seas, an NGO set up by Aquafil and two other parties in 2013 to increase awareness of the problem of discarded fishing nets in the sea." Yet many of the nets recycled by Bonazzi's company, Aquafil, in Slovenia, come from fish farms around the world. Aquafil collects these raw materials in two warehouses of 15,000 square metres each in Ljubljana. Here they are cleaned and strapped to pallets. Other nylon waste, including old carpets, fabric remnants, or plastic parts, is also stored in these facilities. All this is then regenerated in the chemical plant to produce brand-new ECONYL® nylon. The recycling process in the plant can be difficult to follow for the layperson, as most of the chemical separation and melting processes run unseen within a complex system of tanks and pipes running through the plant.

First, we have to look at how waste is handled: fishing nets, for example, are chopped into small pieces and fed into a large tank via a moving conveyor. But at the next station one level up, where some of the material becomes visible outside the silver-coloured pipes, it is already in the form of snow-white plastic granules. Finally, the material is fed through spinneret plates, spun into an endless flat thread, and then wound onto large-scale spools.



Another area of the plant packs very large white, jet black, red, and blue spools of yarn onto roller conveyors.

As a pioneer of this recycling technology, Giulio Bonazzi operates the only plant in the world to manufacture ECONYL® nylon yarn from waste. His product can be recycled any number of times without affecting its quality, because it's a closed cycle. "Generally speaking, the automotive industry is also heading in this direction," says Daniela Bohlinger. "Right from the start, we think carefully about the entire product lifecycle and increasingly use materials that can be recycled at their end of life and used for other purposes."

The investment in emission-free drivetrains and the economical use of materials will assist in the targets of the Paris Climate Treaty being reached. "Our CEO, Oliver Zipse, has made a firm commitment to meet these targets," reiterates Daniela Bohlinger. "We are in the process of developing a clear strategy to achieve this ambitious goal by 2030."

Giulio Bonazzi has his own ideas about what it means to make such changes in the industry. "If I'd ever realised how difficult it would all be, I certainly wouldn't have gone through with it," says the entrepreneur, who labels himself as a "crazy guy", with a wry smile. On a tour of the factory, he

shows Daniela Bohlinger an example of the type of problems he has to contend with: "When we recycle the fish farming nets, we need to remove the copper oxide coating that is used to protect these nets against algal growth. Copper oxide is not compatible with nylon, as it has caused a lot of problems during the chemical process. Some years ago we developed a special method of removing copper oxide from fish farming nets. Another challenge relating to these nets is that of transport, as once a fish farming net reaches the end of its useful life, it is considered special hazardous waste, and the transport of waste in general is highly problematic.

For someone wishing to play an active part in ridding the world of pollutants, it is difficult to understand why the import of contaminated waste material into a country for recycling is not permitted. But in the end, recalls Giulio Bonazzi, he managed to persuade the authorities. The nets, still with their cupric coating, now lie here in the plant, ready for a second, more benign existence as a turquoise bathing suit, a white designer chair, or a stylish black floor mat in a BMW.

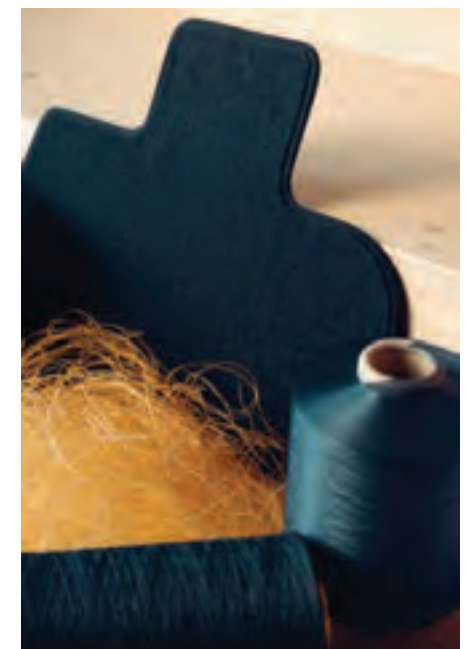

CONSUME LITTLE, ACHIEVE EVERYTHING: SUSTAINABILITY.

Sustainability is in the DNA of BMW, long before the driving pleasure begins. From the selection and processing of raw materials, through the actual production in our plants, to recycling: BMW is

constantly developing electric mobility to keep the ecological footprint as small as possible. This makes driving all the more enjoyable – even for our future generations.

SUPPLY CHAIN CONTROL.

Sustainability starts in the mind and has a wide reach. At BMW, sustainability can be felt in all business areas – and involves much more than just saving CO₂. From the procurement of raw materials to the production of electric vehicles and the recycling of a BMW, **our goal** is to follow the path towards a sustainable automotive future step by step.



Sustainability, from the very first step.

This is where it all begins: Raw materials. Even their procurement is an important component of sustainable production. That's why BMW is taking a very close look here: Are all human rights comprehensibly observed? Are environmental and social standards observed? Not only do we select our suppliers and producers particularly critically, we also become active ourselves in projects and measures to improve the working conditions of the people involved in the procurement of these raw materials.



VEHICLE PRODUCTION.

100% REGENERATIVE ELECTRICITY FOR 100% DRIVING PLEASURE. Sun, wind and innovative technologies: By using green electricity from renewable sources, BMW also minimises the amount of emissions

and CO₂ when manufacturing vehicles. Three plants have made a start here – since 2020 BMW only uses electricity from renewable sources.

Leipzig plant



The agile BMW i3 and the sporty BMW i8 are built in the halls. In front of it, four 190-metre-high wind turbines circle: They produce up to 28 gigawatts of electricity per hour, which is stored in a battery farm consisting of 700 recycled BMW i3 batteries.

Shenyang plant, China



Where the flexible BMW iX3 sees the light of day, the sun shines down on the BMW Group's most powerful photovoltaic system and produces over 15 megawatts of electricity – more than enough to make a BMW i3 drive around 7 million kilometres.

Dingolfing plant



The largest BMW plant in Europe operates in a particularly sustainable manner: The company's own cogeneration plant generates electricity and heat at the same time and covers around 50 percent of energy requirements. The rest also comes 100 percent from renewable energy sources.

THE MATERIAL CYCLE OF A BATTERY CELL.

A battery cell goes through four stages of life in an electric vehicle: Development, use in the vehicle, second life, and battery recycling. We accompany

battery cells on their journey from their development in the BMW Group Competence Centre to their recycling.

Developing the battery cell technology of tomorrow: in the Battery Cell Competence Centre in Munich, the BMW Group searches for the ideal chemical composition for electrodes in a battery cell.

We can compare the development process of a lithium-ion battery cell with baking a cake. The cell chemistry is the recipe, while the four ingredients are the four components: the cathode, anode, separator, and electrolyte.

The battery cells are assembled into battery modules and the individual battery modules into batteries. The key phase in a battery's life now begins, namely its use in the vehicle.

Even when the battery in the vehicle has reached the end of its useful life after many years, it is not the end for the batteries by any means. In the Leipzig plant, for example, BMW i3 batteries are used for the temporary storage of power. This second life use means that the battery cell can be used for another ten years on average as an energy store.

After the battery cells are shredded, their raw materials can be recycled. The BMW Group develops the recycling of secondary raw materials in the Battery Cell Competence Centre. The battery cell's lifecycle is then complete, ready to begin again.

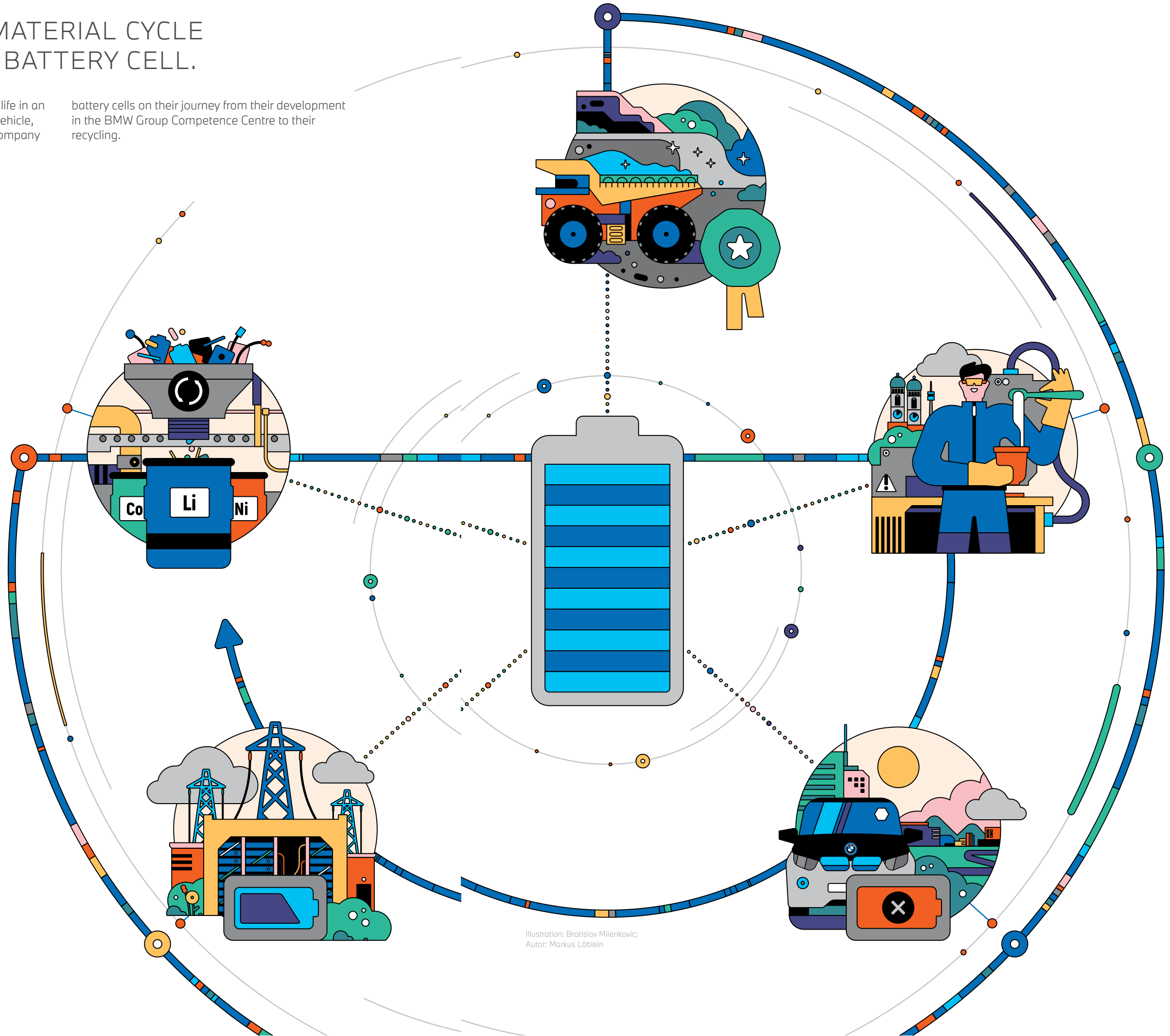
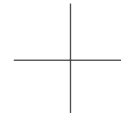

Illustration: Bratislav Milenkovic; Autor: Markus Löblein

WELCOME TO THE BMW GROUP PLANT DINGOLFING.



At present, the largest European BMW production site assembles around 1,300 vehicles daily, but the areas outside the halls are also a hive of activity and production with up to 500,000 bees producing honey and adding to the location's rich biodiversity.

The north side of the BMW Group Plant Dingolfing on a sunny morning: vehicles constantly accelerating, changing gears in a split second, decelerating – this is the plant's test track, used daily to test the latest BMW models. Ears that are attuned to the sound can pick out petrol and diesel models. Now and then a low hum can be heard, combined with tread noise, as a pre-series model of the fully electric BMW iX is put through its paces. The groundbreaking Sports Activity Vehicle (SAV) will roll off the assembly lines here from 2021.

In contrast, the scene on the east side of the premises is quite idyllic, a biotope created by BMW itself. Aquatic plants, flowering shrubs, and an integrated stone plateau create the perfect conditions for insects

such as dragonflies and pond skaters to thrive. Frogs, newts, slow worms, and grass snakes also feel at home in this ideal habitat for a vast range of organisms. While around 17,000 employees work in the plant to assemble a range of models from the BMW 3 Series to the 8 Series, up to another half a million "workers" inhabit the grounds outside, as 13 species of bee have made their home on the company premises, all watched over by a BMW employee, an expert who also sits on the management committee of the Dingolfing Beekeepers' Association.

The bee colonies are just one of the many steps taken by BMW to support biodiversity. Scores of fruit trees have been planted, while grassed areas have been transformed into flower beds and wildflower meadows. In total, 100 nesting boxes and insect



▶ 13 bee colonies support biodiversity at the site, and produce delicious honey.

the building's climate in both summer and winter: Evaporation on warm days produces a cooling effect, while in cold weather, the improved insulation has a positive impact on energy efficiency.

The BMW Group Plant Dingolfing is therefore not only a pioneer of future technologies and future-proof workplaces with the new fully electric BMW iX, but is also creating ecological habitats on the site. This is how the Lower Bavarian plant continues not only to honour its commitment to sustainable use of energy, water, and air, but also to increased biodiversity. The bees are of course oblivious to all this as they fly from flower to flower, producing their honey from the "Dingolfing Hive".

hotels have been added. These were presented to the Dingolfing plant by Landshuter Werkstätten and make a vital contribution to the success of this environmental project. Yet it is not only insects and small birds that take advantage of this new habitat, as perches for birds of prey are also dotted around the grounds. Buzzards, falcons, and hawks use the five metre high structures as a spot to which they can retreat and observe their prey. This helps maintain a well-balanced food chain. The basic concept of existing in harmony with nature is evident in many places around the company premises. Green roof systems adorn a number of buildings. Planted with flowering stonecrop, they offer more than just a home for insects. This greening helps during heavy rain, as the rainwater is absorbed by the roof's substrate layer. It also helps temper

▶ A burning passion for beekeeping: Stefan Fleischmann, Environmental Officer in the paint shop at the BMW Group Plant Dingolfing, established the bee colony at the site.



BMW iX		xDrive40
Communication		
System output	kW/(hp)	240 / (326)
System torque	Nm	630
High-voltage battery and charge data		
Net HV battery capacity	kWh	71
Charging time (AC 0-100%) ²	h	7.25
Charging time (DC 10-80%) ²	min	31
Basic data		
Type of drive	-	All-wheel
Transmission type	-	Automatic
Performance		
Top speed	km/h	200 ⁷
0-100 km/h	s	6.1
Consumption and range		
WLTP ^{3,5}		
► combined electric consumption ^{4,8}	kWh/100 km	19.4-22.5
► Electric range ^{6,8}	km	425-372
Wheels/tyres		
Standard wheels	-	Front: 255/50 R21 Rear: 255/50 R21

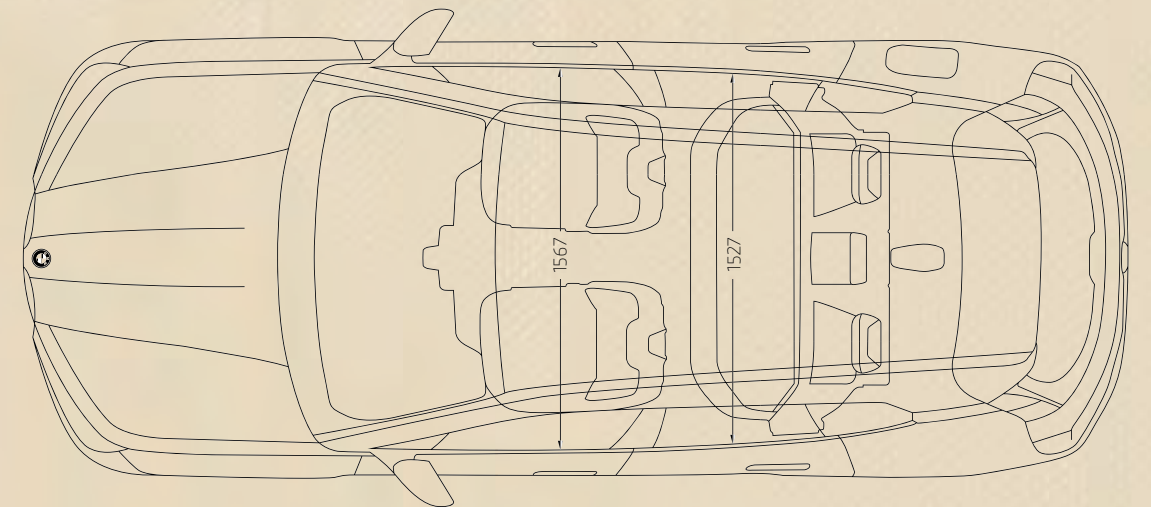
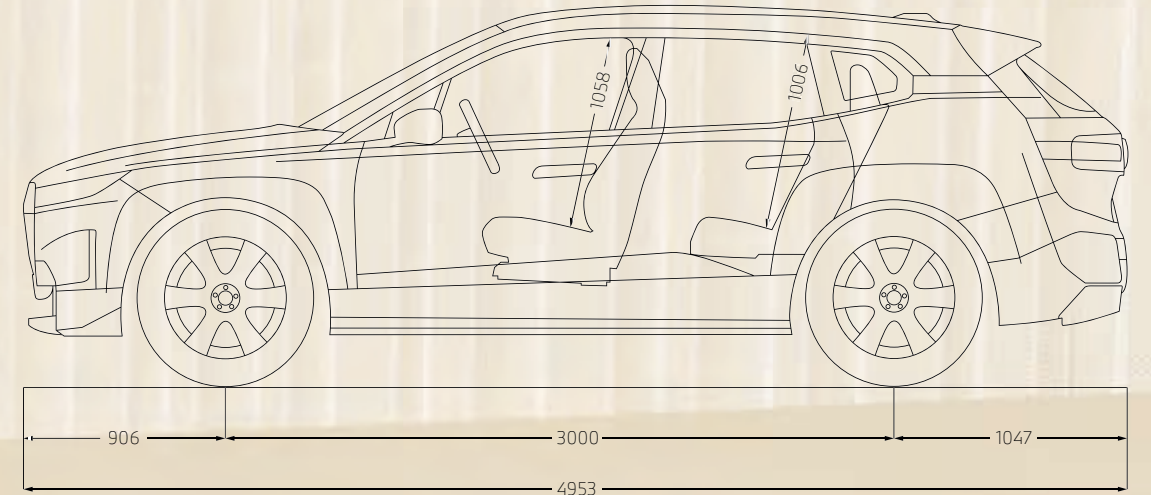
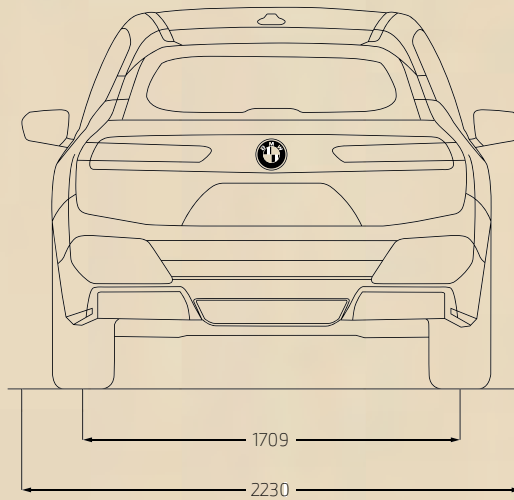
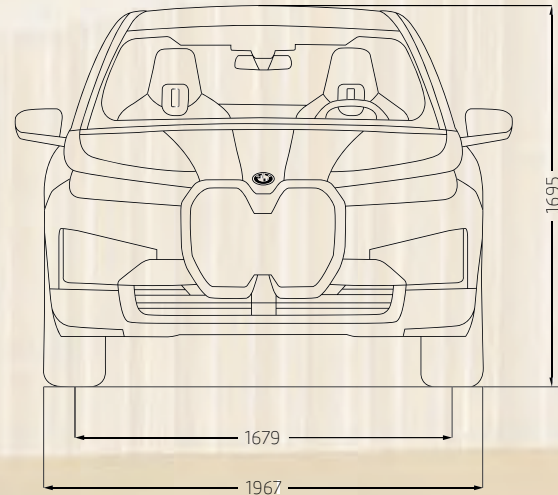

The dimensions in the technical drawing are in millimetres and may vary depending on the model and equipment.

¹ The figures quoted are based on a driver weight of 75 kg. Unladen weight applies to vehicles with standard equipment. Optional equipment may affect the weight of the vehicle, the payload and the top speed if the equipment has an impact on the vehicle's aerodynamics.
² Dependent on the local electricity infrastructure. Charging time AC is based on charging power of 11 kW, charging time DC is based on charging power of up to 150 kW for xDrive40.
³ Official data for power consumption and range were determined in accordance with the measuring procedures as defined by European Regulation (EU) 715/2007 in the applicable version and comply with same. In the event of ranges, data determined as per WLTP takes into account any optional equipment (available on the German market in this case). For vehicles that have been newly type approved since 1 January 2021, only the official data according to WLTP exist. For more information about NEDC and WLTP measuring procedures visit www.bmw.in/wltp
⁴ The combined electrical consumption depends on the selected wheel and tyre sizes.

⁵ From 1 September 2017, certain new vehicles are tested according to the Worldwide Harmonised Light Vehicles Test Procedure (WLTP) before type approval is granted – WLTP provides a new, more realistic way of measuring fuel consumption and CO₂ emissions. As of 1 September 2018, the WLTP replaced the New European Driving Cycle (NEDC), the previous test procedure. As a result of the more realistic test conditions, the fuel consumption and CO₂ emission values measured as per WLTP are, in many cases, higher than the values measured according to the NEDC.
⁶ Range depends on various factors, in particular: individual driving style, route characteristics, outside temperature, heating/air conditioning, pre-conditioning.
⁷ Electronically limited.
⁸ A Performance data as measured in the Range and consumption test done under controlled conditions of environment, driving cycle etc. as specified in Rule 115 of Central Motor Vehicle Rules, 1989: Range: 446 km, Consumption: 21.1 kWh/100 km.

SUSTAINABILITY, TANGIBLY EFFECTIVE.

Sustainability has many facets – and each one of them is important. For this reason, the printed product that you hold in your hands is printed on NAUTILUS® paper made by the manufacturer Mondi.

This uncoated paper consists entirely of recycled waste paper, meets the EU Ecolabel requirements among others and was certified by the Forest Stewardship Council, an international non-profit organisation for the protection of forests. Any pulp that is used originates exclusively from FSC™-certified, sustainably managed forests.

To reduce the ecological footprint even further, investments are being made in the Pesqueiro hydropower plant to compensate the CO₂ generated during production, saving some 20,000 tons of CO₂ emissions every year.

This results in CO₂-neutral paper – a result that you can feel but that, above all, helps to preserve our planet's resources for all future generations.



EU Ecolabel - AT/11/001

BMW EXTENDED WARRANTY AND SERVICE PACKAGE.



The new BMW iX will run well when it's kept well. And to make your journey one with complete peace of mind, we have packages under BMW Service and Repair Inclusive that take care of maintenance, inspection, wear and tear and warranty.

BMW Service Inclusive (BSI)

A single up-front payment covers an extensive range of work on your the new BMW iX for a fixed period.

Complete Cost Control.¹

Integrate the cost of service work in your leasing and finance installments.

Fully Flexible.

You have a choice of various packages with different durations. You can choose from 4 years to 10 years. Service packages are capped with a maximum mileage of 2,00,000km.

Easily Transferable.

Consistent maintenance by trained BMW Certified Technicians and the use of Original BMW Parts secure the value of your car in the long term. In case you sell your car, BMW Service Inclusive is automatically transferred to the next owner – an additional selling point.

BMW Repair Inclusive (BRI)

BRI offers the ease of extending the warranty of your car with unlimited mileage up to 5 years. BRI too is automatically transferred to the next owner in the event of selling your car.

	Service Inclusive Packages	Service Inclusive	Service Inclusive Plus	Repair Inclusive
Scope of Services				
Maintenance	Service standard scope	✓	✓	
	Vehicle check service	✓	✓	
	Micro filter service	✓	✓	
	Brake fluid service	✓	✓	
	Charging high voltage battery up to 75 - 80%	✓	✓	
Wear Parts	Service Wiper Blades (once per year)		✓	
	1 set of brakes (front + rear, discs + pads)*		✓	
	Warranty extension			✓

¹Applicable only with BMW India Financial Services Private Limited during the initial purchase of the vehicle (not on other finance or during upgrades).

BMW FINANCIAL SERVICES.

BMW Financial Services
Realize the dream.

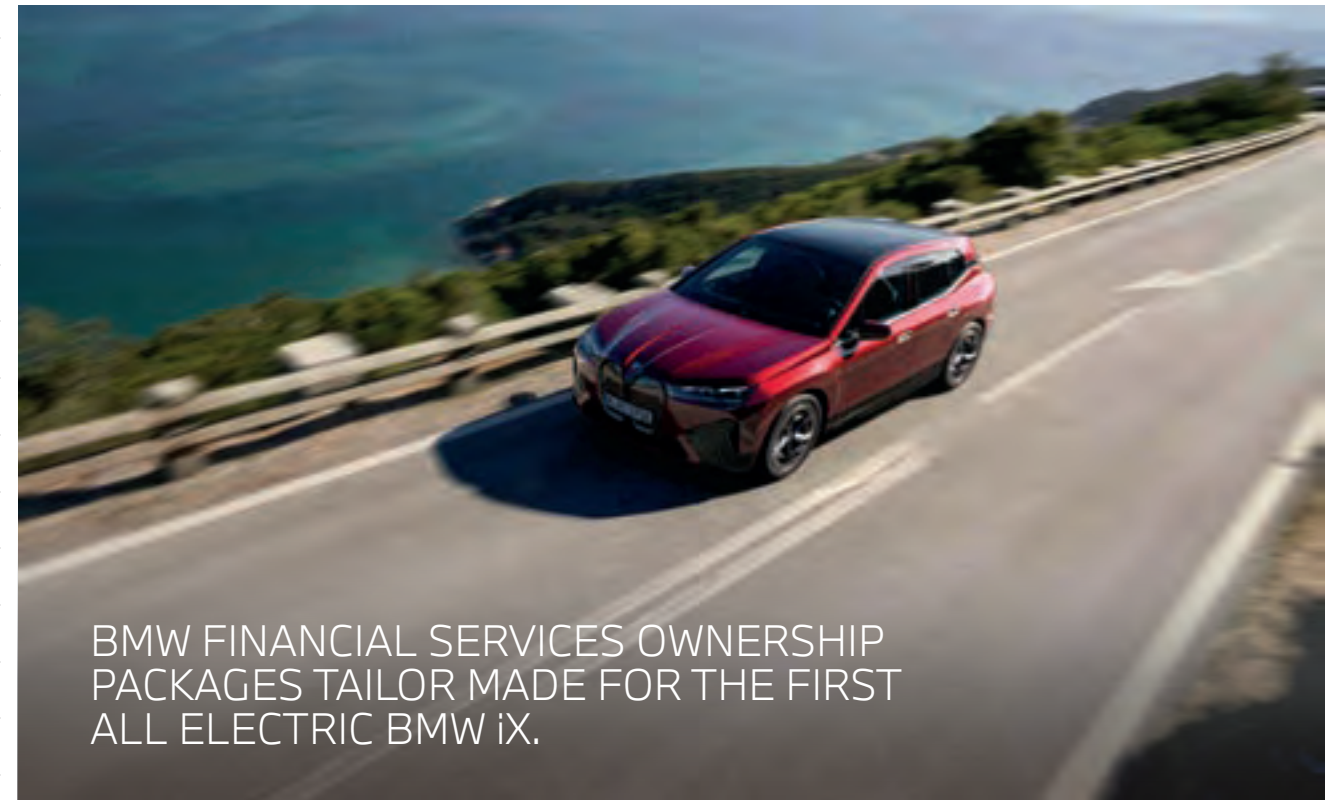

BMW FINANCIAL SERVICES OWNERSHIP PACKAGES TAILOR MADE FOR THE FIRST ALL ELECTRIC BMW iX.

In the world of BMW, world-class isn't limited to the vehicles we engineer. It also finds its way into the services we offer. BMW Financial Services is the most flexible and efficient way to realise your dream of owning your new BMW iX. Our goal is to make your financing experience seamless at every step of your purchase so that nothing comes between you and the joy of driving your BMW.

Complete peace of mind.

BMW Financial Services offers you complete packages for loan, insurance and vehicles services that ensures complete peace of mind. With us, you are assured of quick approvals with fast turnaround time, special loyalty benefits and part payment facility.

Own it with the ultimate finance - bmw 360° plan.



- Best-in-class guaranteed assured buyback to future-proof your BMW iX.
- 40% Lower monthly payment.
- Flexibility to upgrade, retain or return at the end of your contact.

BMW insurance solutions and services.

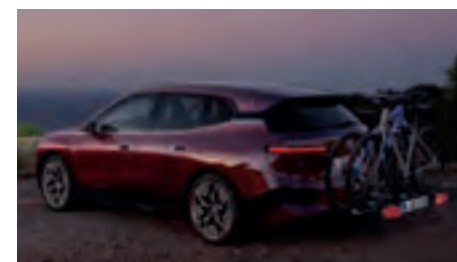

- Our comprehensive insurance program provides maximum protection with additional options such as zero depreciation, battery cover and return to invoice.
- Our Road-side assistance cover offers complete peace of mind while on the move with facilities like portable roadside charging.

BMW INDIA NETWORK.

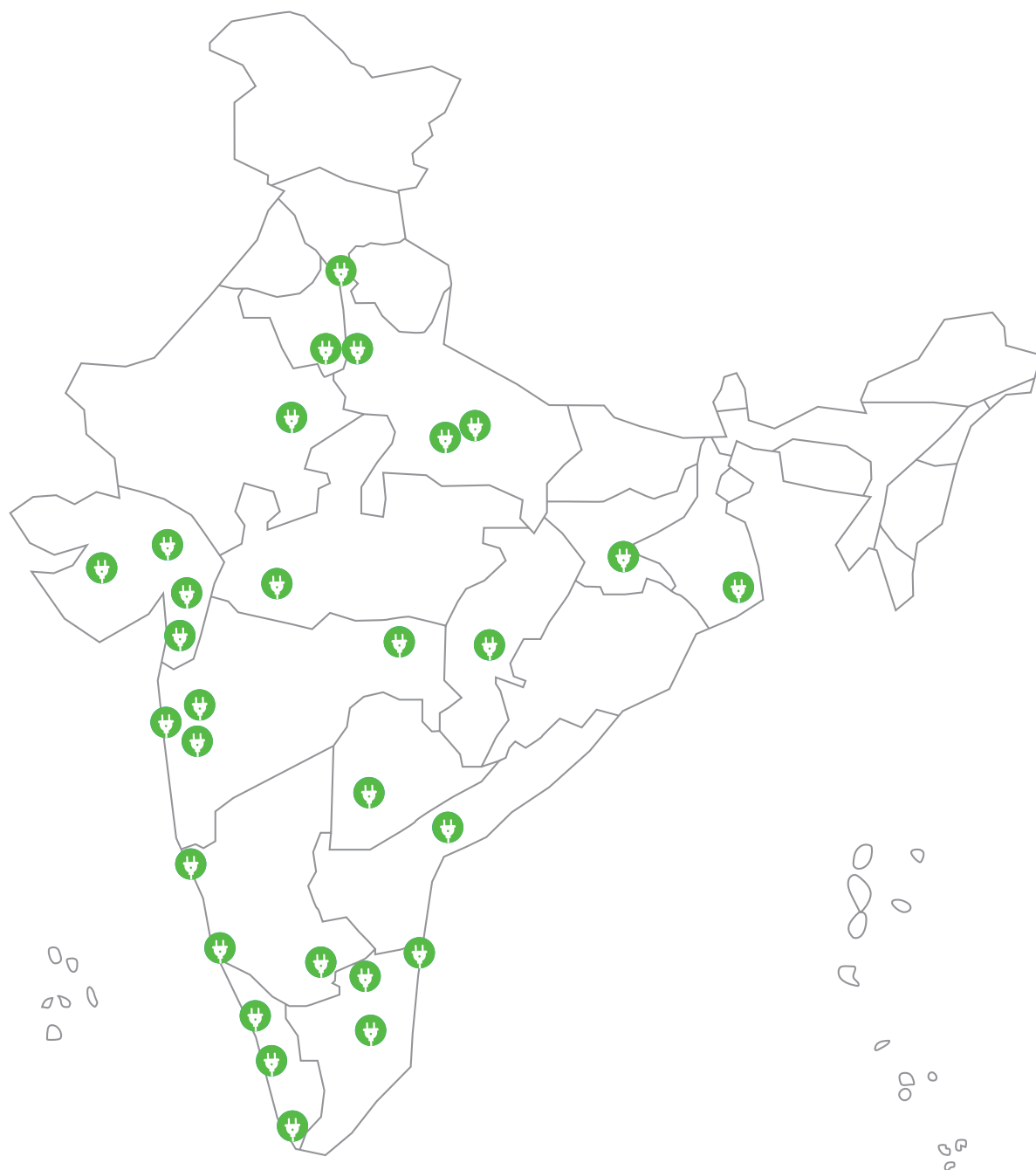

The pictorial representation does not purport to be the political map of India.

DEALERSHIPS.

NORTH

BMW Bird Automotive

- SW 4IDC, MG Road, Gurugram
- S Golf Course Road, Sector 56 Gurugram

BMW Deutsche Motoren

- S Mohan Cooperative, Mathura Road New Delhi
- W Shivaji Marg, Moti Nagar, New Delhi
- SW Sector 27B, Mathura Road, Faridabad
- SW Sector 63, Noida

BMW Infinity Cars

- S Rajouri Garden, New Delhi
- W Mayapuri, New Delhi

BMW Krishna Automobiles

- SW Industrial Phase 1, Chandigarh
- SW GT Road, Ludhiana

BMW Sanghi Classic

- SW Tonk Road, Jaipur
- S Madri Industrial Area, Udaipur*

BMW Speed Motorwagen

- SW Chinhat, Lucknow
- SW Kalpi Road, Kanpur

EAST

BMW OSL Prestige

- S Silver Arcade, Kolkata
- W East Topsia Road, Kolkata
- SW Bhanpur, Cuttack*

BMW Titanium Autos

- SW Ormanjhi, Ranchi

WEST

BMW Bavaria Motors

- S Wellesley Road, Pune
- W Hadapsar, Pune
- SW Verna, Goa
- SW Chikalthana, Aurangabad*

BMW Eminent Cars

- SW Surat-Dumas Road, Piplod, Surat
- SW Sunpharma Road, Vadodara

BMW Gallops Autohaus

- SW S G Highway, Sarkhej, Ahmedabad
- SW Gondal Road, Rajkot

BMW Infinity Cars

- S Worli, Mumbai
- S Nariman Point, Mumbai
- S Vashi, Navi Mumbai
- W Lalbaug, Mumbai
- W Worli, Mumbai
- W Turbhe, Navi Mumbai
- SW Dewas Naka, Indore

BMW Munich Motors

- SW Sarona, Raipur
- SW Hingna MIDC, Nagpur

BMW Navnit Motors

- S Juhu, Mumbai
- S Malad, Mumbai
- W Andheri, Mumbai
- W Gokul Nagar, Thane

SOUTH

BMW Deutsche Motoren

- S Whitefield, Bengaluru
- W Whitefield, Bengaluru

BMW EVM Autokraft

- SW Kalamassery, Kochi
- S Kovalam Road, Trivandrum
- W Kochuveli, Trivandrum

BMW KUN Exclusive

- S Khairtabad, Hyderabad
- S Jubilee Hill, Hyderabad
- W RTC, Cross Road, Hyderabad
- SW Mangalagiri, Vijayawada

BMW KUN Exclusive

- SW Meenambakkam, Chennai
- S EA Mall, Chennai
- S Ambattur, Chennai
- S OMR, Chennai
- W Ambattur, Chennai
- SW Avinashi Road, Coimbatore
- SW Virudhunagar, Madurai

BMW Varsha Autohaus

- SW Mangalore-Bangalore Highway, Mangalore

BMW Navnit Motors

- S Lavelle Road, Bengaluru
- W Bethahalasoor Post, Bengaluru
- SW Hosur Road, Bengaluru

*Disclaimer: These facilities are not equipped with charging infrastructure.

SW Showroom and Workshop S Showroom W Workshop

SEARCH



Scan to visit the
BMW Online Shop



For more information, call 1800 102 2269.

The models, equipment and possible vehicle configurations illustrated in this brochure may differ from vehicles supplied in the Indian market. For precise information, please contact your local Authorised BMW Dealer. Subject to change in design and equipment. © BMW India Pvt. Ltd., Gurgaon, India. Not to be reproduced wholly or in part without written permission of BMW India Pvt. Ltd., Gurgaon, India. Compliance under Legal Metrology Act.