

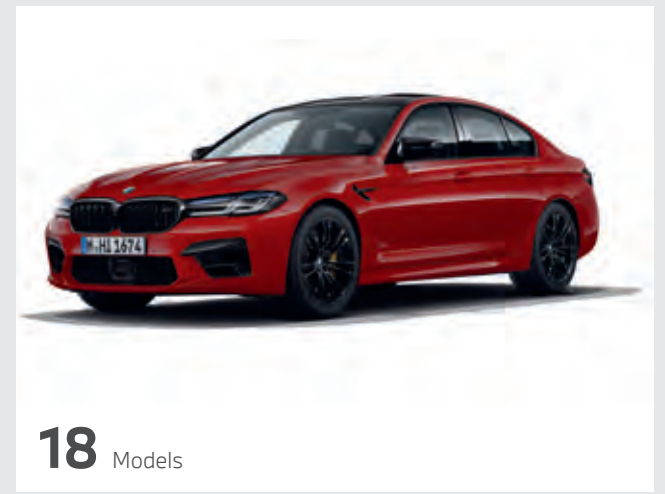

THE M5



THE BMW M5.



18 Models



20 Highlights

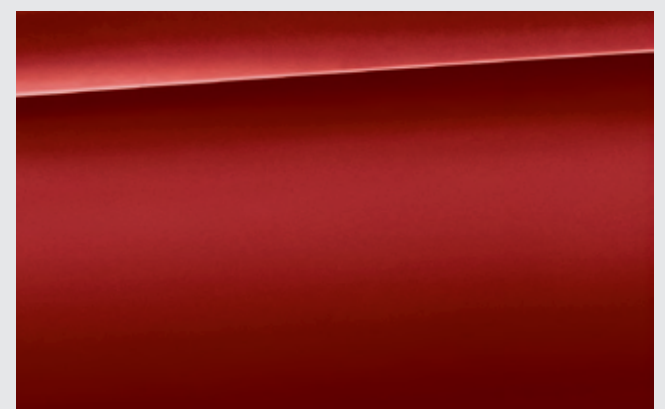

24 Colour worlds

DISCOVER MORE.



Scan the code to get more information and more driving pleasure on the all-new BMW M5 Competition.

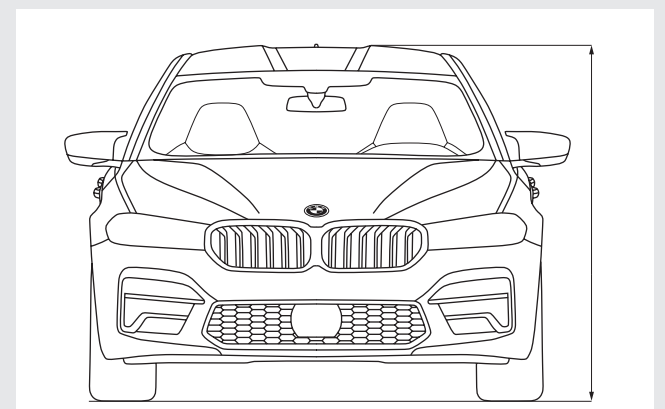

26 Technical data

THE M5 COMPETITION



>> DAY 01 — SHOT 0249

GIVE M5.



HEARTBEAT
ACCELERATOR.



HEADSPINNER.





LOST IN FULL SPACE.



>> DAY 05 — SHOT 0587



THE M5 COMPETITION

>> DAY 03 — SHOT 0450

LIMIT ENHANCEMENT.



ENDORPHINAL.



HIGHER CLASS.

THE BMW M5 COMPETITION.



THE M5 COMPETITION

>> DAY 04 — SHOT 0098

■ Standard equipment □ Optional equipment



■ The M Leather steering wheel including multifunction buttons, an M badge and an integrated driver-side airbag is featured in three-spoke design. With a steering wheel rim in leather 'Walknappa' Black with black stitching and contoured thumb rests, it provides a direct, athletic steering experience.

■ The M Multifunctional seats for driver and front passenger in exclusive design offer comprehensive adjustment possibilities and provide perfect support.



■ 20" M light alloy wheels Double-spoke style 706 M Black with mixed tyres, wheel size front 9.5J x 20 with 275/35 R20 tyres, wheel size rear 10.5J x 20 with 285/35 R20 tyres.



□ Thanks to the use of a special material mix, M Compound brakes with brake calipers in Red high-gloss achieve outstanding deceleration values and are extremely stable and highly durable.

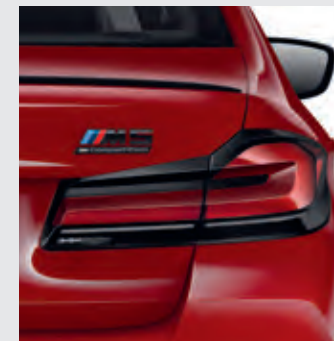

■ The black "M5 Competition" designation on the rear is an indication of the vehicle's extraordinarily high driving dynamic potential.

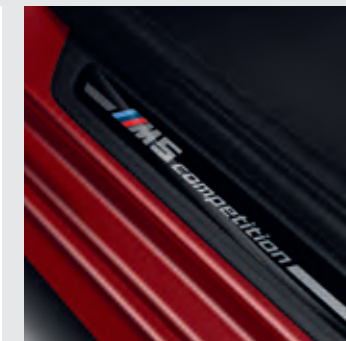

■ As soon as the door is opened, the illuminated door sill finishers with "M5 Competition" designation increase the thrill of anticipation for the following driving experience.

HIGHLIGHTS.

Discover even more with the new BMW Brochures app. Available now, for your smartphone and tablet.

■ Standard equipment □ Optional equipment



■ In laser high-beam mode, BMW Laserlight illuminates a range of up to 650 m, nearly twice as far as that of conventional headlights. Better visibility in the dark significantly increases safety. Blue accents and the lettering "BMW Laser" in the headlight also underline the technological standards and the sportiness of the vehicle.



□ The M Carbon ceramic brake¹ delivers braking power more directly. It is non-corrosive, very resistant to abrasion, tolerates more heat and contributes to a lower vehicle weight, which has a positive impact on agility, dynamics and acceleration. Matt Gold-coloured brake calipers with the M designation make this special technical equipment visible from outside the vehicle.



■ The BMW Live Cockpit Professional with navigation function includes two high-quality displays consisting of a high-resolution 12.3" Control Display that can be operated by touch and a fully digital 12.3" instrument display. The BMW Operating System 7 can also be operated via the iDrive Touch Controller.



□ The Bowers & Wilkins Diamond surround sound system with two diamond tweeters features outstanding studio-quality sound for every seat in the vehicle. 16 carefully positioned speakers ensure a mesmerising sound experience. The speakers are illuminated, visually emphasising the system's outstanding sound quality.

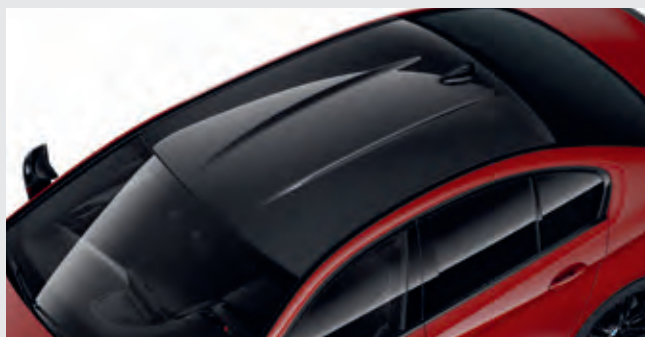

■ As part of the intelligent lightweight construction concept, the M carbon-fibre roof helps to reduce the vehicle's weight. It consists of carbon-fibre reinforced plastic (CFRP) and is 800 g lighter than a comparable aluminium standard roof. That way, the centre of gravity of the vehicle is shifted downwards and the driving dynamics are increased.



■ The full-colour BMW Head-Up Display² with M specific functions projects information relevant for the journey directly into the driver's field of vision. With the press of a button, the driver can switch to the M specific display, which includes a gear indicator, the rpm as a dynamic range curve with shift lights indicating the optimal moment to shift as well as navigation tips.



■ Ambient light, including Ambient contour lighting in the front and rear doors, creates a relaxed, cosy lighting atmosphere in the interior. The six dimmable lighting designs also include a dynamic function in four applications.



■ The M Setup allows you to configure various driving dynamics parameters according to your individual requirements.

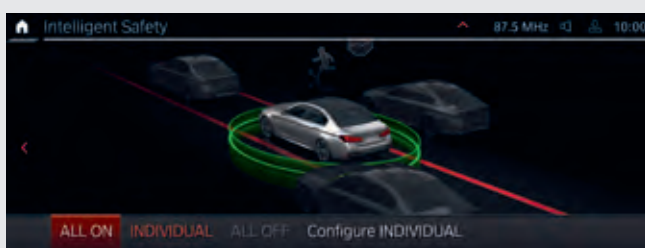

□ Driving Assistant Professional³ * offers optimum comfort and safety during critical or monotonous traffic situations. Apart from the contents of the Driving Assistant, it also includes Steering and Lane Control Assistant with extended functions, Emergency Stop Assistant and Lane Keeping Assistant with active side collision protection.



□ Parking Assistant Plus makes parking and manoeuvring the vehicle easier. It features among others the Surround View system including Top View, Panorama View, Remote 3D View, as well as a lateral parking aid, the emergency braking function Active Park Distance Control, Parking Assistant⁴ with longitudinal and lateral guidance and Reversing Assistant.

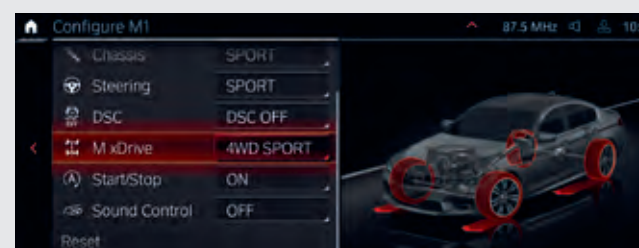

■ BMW M xDrive with Active M differential guarantees maximum traction and driving dynamics for everyday driving, as well as at the racetrack. The M specific technology combines the typical agility of a rear-wheel drive with the control of an all-wheel drive. You can choose between the drive variants 4WD, 4WD Sport and – in DSC-off mode – 2WD.

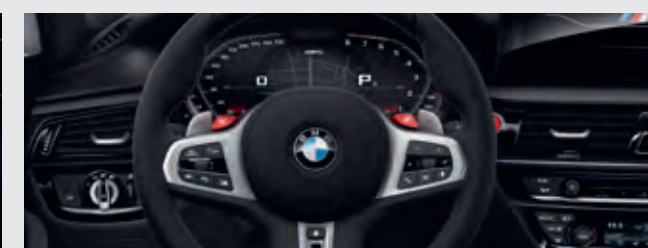

The 8-speed M Steptronic transmission with Drivelogic features extremely short shifting times and numerous shifting options.

¹ Depending on conditions and usage, features specific to the materials used can lead to operational noises, particularly in wet conditions, just before the vehicle comes to a halt.

² The information in the BMW Head-Up Display is not fully visible when viewed through polarised sunglasses.

³ Function may be limited in darkness, fog or bright glare.

⁴ The driver is responsible for constantly monitoring the automated parking procedure in accordance with local road laws.

Please consult your local BMW partner for more information.

*The availability of some equipment features and functions depends on engine variants or additional options. The market and production availability may vary. You can find detailed information about duration, standard and optional equipment at www.bmw.in or at your BMW Partner.

EXTERIOR COLOURS.

Discover even more with the new BMW Brochures app. Available now, for your smartphone and tablet.

■ Standard equipment □ Optional equipment

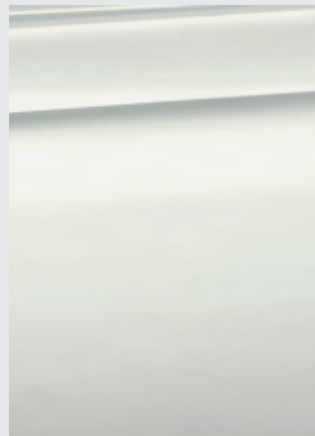

■ Non-metallic 300 Alpine White



■ Metallic C28 M Donington Grey



■ Metallic C2Y Bluestone

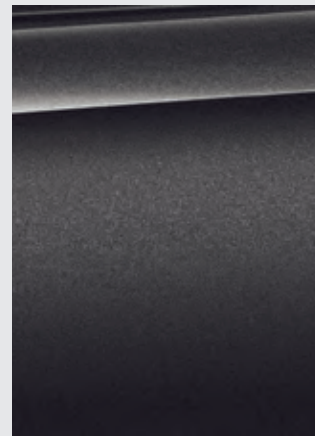

■ Metallic C17 M Brands Hatch Grey

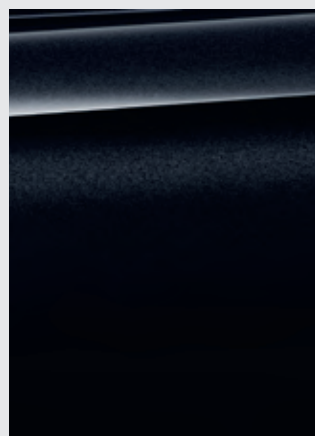

■ Metallic 475 Black Sapphire



■ Metallic C1K M Marina Bay Blue



■ Metallic C1G Snapper Rocks Blue



■ Metallic C3K M Motegi Red

BMW INDIVIDUAL

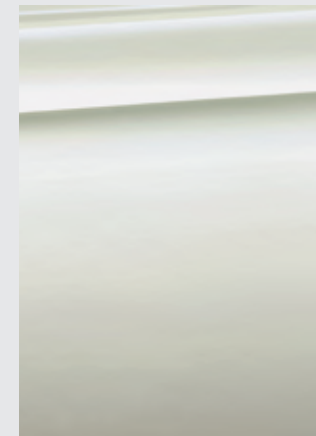

□ BMW Individual special paintwork Brilliant White metallic

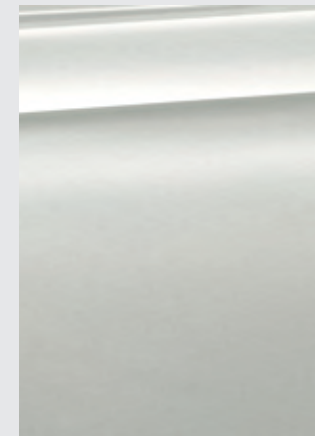

□ BMW Individual special paintwork Frozen Brilliant White metallic



□ BMW Individual special paintwork Pure metal Silver

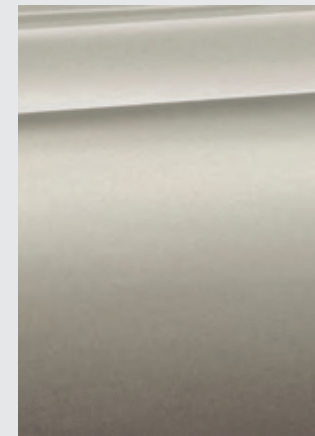

□ BMW Individual special paintwork Frozen Cashmere Silver metallic

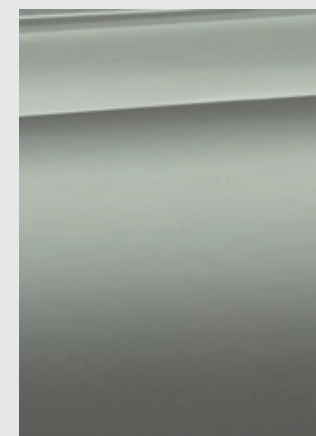

□ BMW Individual special paintwork Frozen Dark Silver metallic

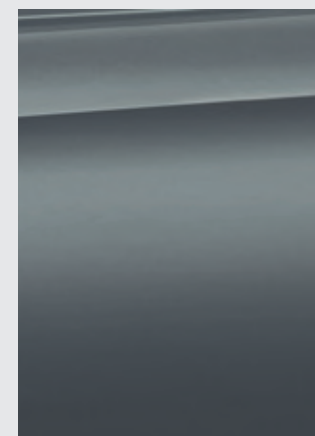

□ BMW Individual X1D Frozen Bluestone metallic

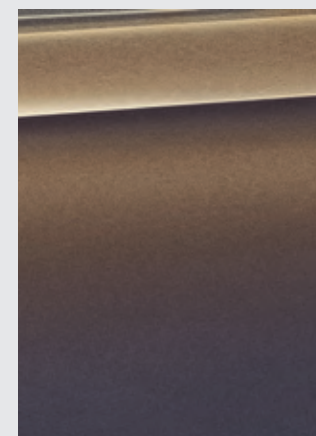

□ BMW Individual C5E Alvite Grey metallic



□ BMW Individual special paintwork Frozen Marina Bay Blue metallic



□ BMW Individual C3Z Tanzanite Blue metallic

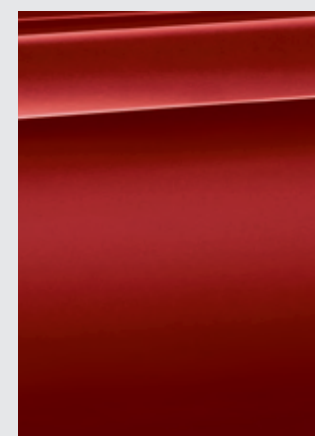

□ BMW Individual special paintwork Imola Red

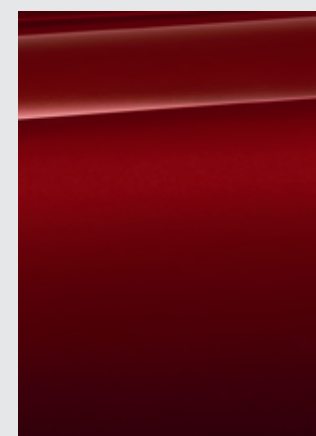

□ BMW Individual X1C Aventurine Red metallic

The availability of some equipment features and functions depends on engine variants or additional options. The market and production availability may vary. You can find detailed information about duration, standard and optional equipment at www.bmw.com or at your BMW Partner.

[Colour samples] These colour samples are intended as an initial guide to the colours and materials available for your BMW. However, experience has shown that printed versions of paint, upholstery and interior trim colours cannot in all cases faithfully

reproduce the appearance of the original colour. Please discuss your preferred colour choices with your BMW partner or in your dealership. There you can also see original samples and be assisted with special requests.

INTERIOR COLOURS.

Discover even more with the new BMW Brochures app. Available now, for your smartphone and tablet.

■ Standard equipment □ Optional equipment



LEATHER

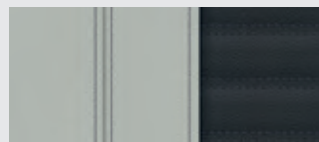

■ Leather 'Merino' LKA9 with extended contents Silverstone Bicolour

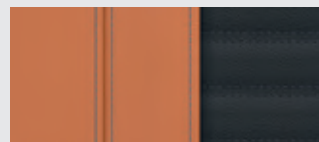

■ Leather 'Merino' LKD8 with extended contents Bicolour Aragon Brown

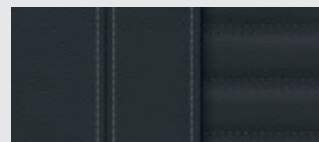

■ Leather 'Merino' LKSW with extended contents Black

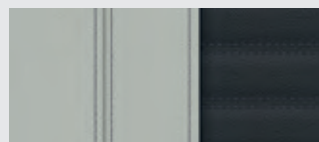

□ Full leather 'Merino' X3A9 Bicolour Silverstone*

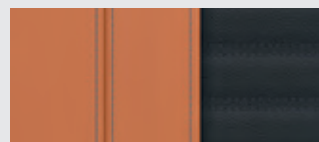

□ Full leather 'Merino' X3D8 Bicolour Aragon Brown*

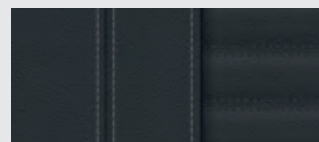

□ Full leather 'Merino' X3SW Black*

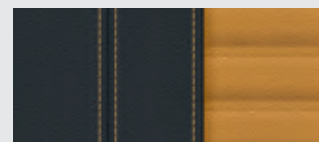

□ Full leather 'Merino' X3JA Black, contrast Midrand Beige

BMW INDIVIDUAL LEATHER

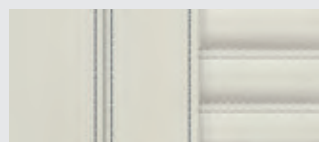

□ BMW Individual full leather trim 'Merino' ZBFU Smoke White*

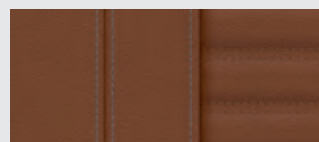

□ BMW Individual full leather trim 'Merino' ZBTQ Tartufo*

INTERIOR TRIM FINISHERS

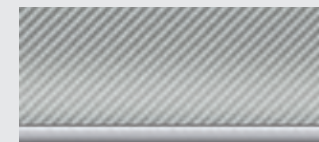

■ M interior trim finishers Aluminium Carbon structure with highlight trim finisher Pearl Chrome

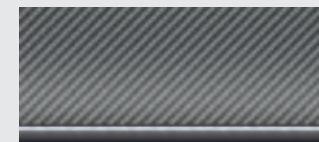

■ M interior trim finishers Aluminium Carbon structure dark with highlight trim finisher Chrome dark

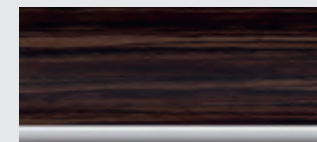

■ Fine-wood trim 'Fineline' Ridge with highlight trim finisher Pearl Chrome

BMW INDIVIDUAL INTERIOR TRIM FINISHERS

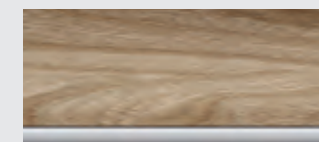

■ BMW Individual fine-wood trim Sen light brown with highlight trim finisher Pearl Chrome



■ BMW Individual fine-wood trim plum brown high-gloss with highlight trim finisher Pearl Chrome

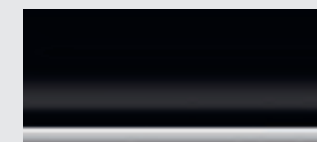

■ BMW Individual interior trim finishers piano finish Black with highlight trim finisher Pearl Chrome

Please note that even normal long- or short-term use can lead to unrecoverable upholstery damage. This can be caused in particular by non-colourfast clothing.

Please note that the interior colour depends on the selected upholstery colour.

* The availability of some equipment features and functions depends on engine variants or additional options. The market and production availability may vary.

You can find detailed information about terms, standard and optional equipment at www.bmw.com or at your BMW Partner.

BMW M5 Competition

Engine ⁴		
Cylinders/valves		8/4
Capacity	cm ³	4395
Max. output/engine speed	kW (hp)/rpm	460 (625)/6000
Max. torque/engine speed	Nm/rpm	750/1800–5860

Power transmission	
Type of drive	M xDrive
Standard transmission	M Steptronic

Performance		
Top speed	km/h	250 ¹
Top speed with optional M Driver's Package ⁶	km/h	305
Acceleration 0–100 km/h	s	3.3

Wheels/tyres	
Tyre dimensions	275/35 ZR20 Y, 285/35 ZR20 Y
Wheel size	9.5 J x 20, 10.5 J x 20
Material	Light alloy

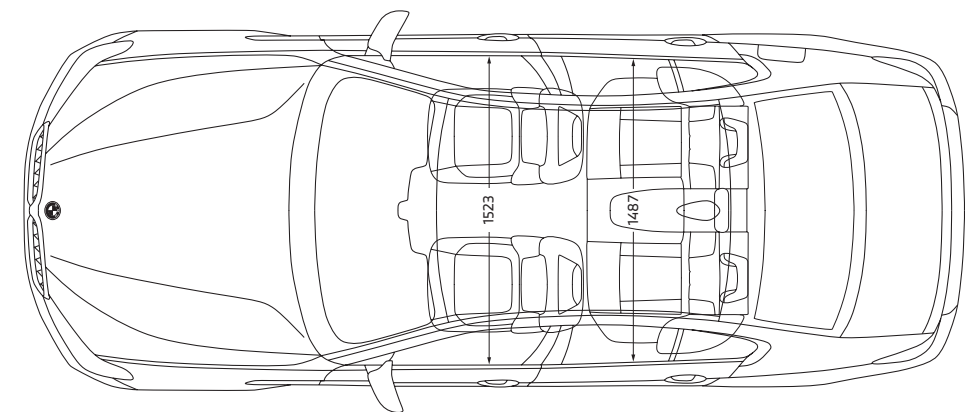
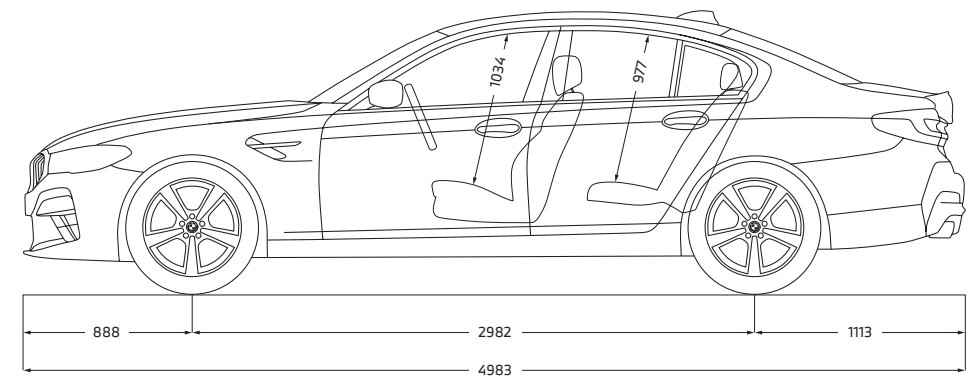
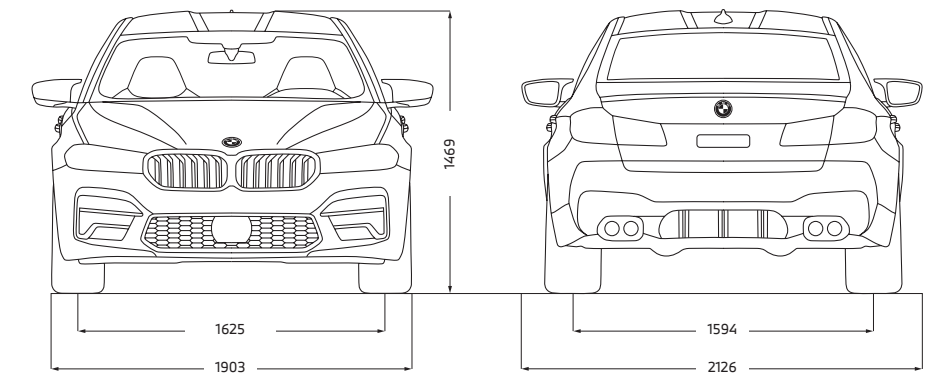

All dimensions in the technical drawing are given in millimetres.

¹ Electronically limited.

BMW EXTENDED WARRANTY AND SERVICE PACKAGES.



A BMW M5 COMPETITION will run well when it's kept well. And to make your journey one with complete peace of mind, we have packages under BMW Service and Repair Inclusive that take care of maintenance, inspection, wear and tear and warranty.

BMW Service Inclusive (BSI)

A single up-front payment covers an extensive range of work on your BMW M5 COMPETITION for a fixed period.

Complete Cost Control.¹

Integrate the cost of service work in your leasing and finance installments.

Fully Flexible.

You have a choice of various packages with different durations and mileage. You can choose from 3 years with 40,000 km to 10 years with 2,00,000 km.

Easily Transferable.

Consistent maintenance by trained BMW Certified Technicians and the use of Original BMW Parts secure the value of your car in the long term. In case you sell your car, BMW Service Inclusive is automatically transferred to the next owner – an additional selling point.

BMW Repair Inclusive (BRI)

BRI offers the ease of extending the warranty of your car with unlimited mileage up to 6 years. BRI too is automatically transferred to the next owner in the event of selling your car.

	Service Inclusive Packages	Service Inclusive Basic	Service Inclusive Plus	Repair Inclusive
Scope of Services		Maintenance All maintenance work, including any BMW Original Parts and oil required.	Wear and Tear Additional wear and tear repairs including any Original BMW Parts required.	Repair Extension of your statutory right to claim for vehicle defects (warranty).
Maintenance	Engine oil service	✓	✓	
	Engine oil top ups	✓	✓	
	Vehicle check and standard scopes	✓	✓	
	Service/replace air filter	✓	✓	
	Service/replace fuel filter	✓	✓	
	Service/replace micro filter	✓	✓	
	Service/replace spark plugs	✓	✓	
	Service/replace brake fluid	✓	✓	
Wear & Tear	Replacement of front/rear brake pads		✓	
	Replacement of front/rear brake discs		✓	
	Replacement of clutch (if necessary)		✓	
	Replacement of wiper blades (once in a year)		✓	
	Extension of your statutory right to claim for vehicle defects (warranty)			✓

BMW FINANCIAL SERVICES.

BMW Financial Services
Realize the dream.



In the world of BMW, world-class isn't limited to the vehicles we engineer. It also finds its way into the services we offer. BMW Financial Services is the most flexible and efficient way to realise your dream of owning a BMW. Our goal is to make your financing experience seamless at every step of your purchase so that nothing comes between you and the joy of driving your BMW.

At BMW Financial Services, you are assured of:

- Tailor-made finance options, as per your specific needs
- Quick approvals with fast turnaround time
- Special loyalty benefits
- Part payment facility
- In-house call centre that provides the best-in-class customer interaction

The BMW 6 Series Gran Turismo comes with an exclusive BMW 360° Plan. It has benefits at every step of the way, all to ensure Sheer Driving Pleasure.

Easy to Buy.

The BMW 360° Plan allows you to pay low monthly installments as you only pay for what you use.

Easy to Own.

BMW offers various options under Service and Maintenance Packages which further reduce your cost of ownership.

Future Proof.

The BMW 360° Plan provides Assured Buyback value at the end of your finance contract.

For more information, contact the Finance and Insurance Manager at the nearest BMW Authorised Dealership.

¹ Applicable only with BMW India Financial Services Private Limited during the initial purchase of the vehicle (not on other finance or during upgrades).

BMW INDIA NETWORK.

DEALERSHIPS.

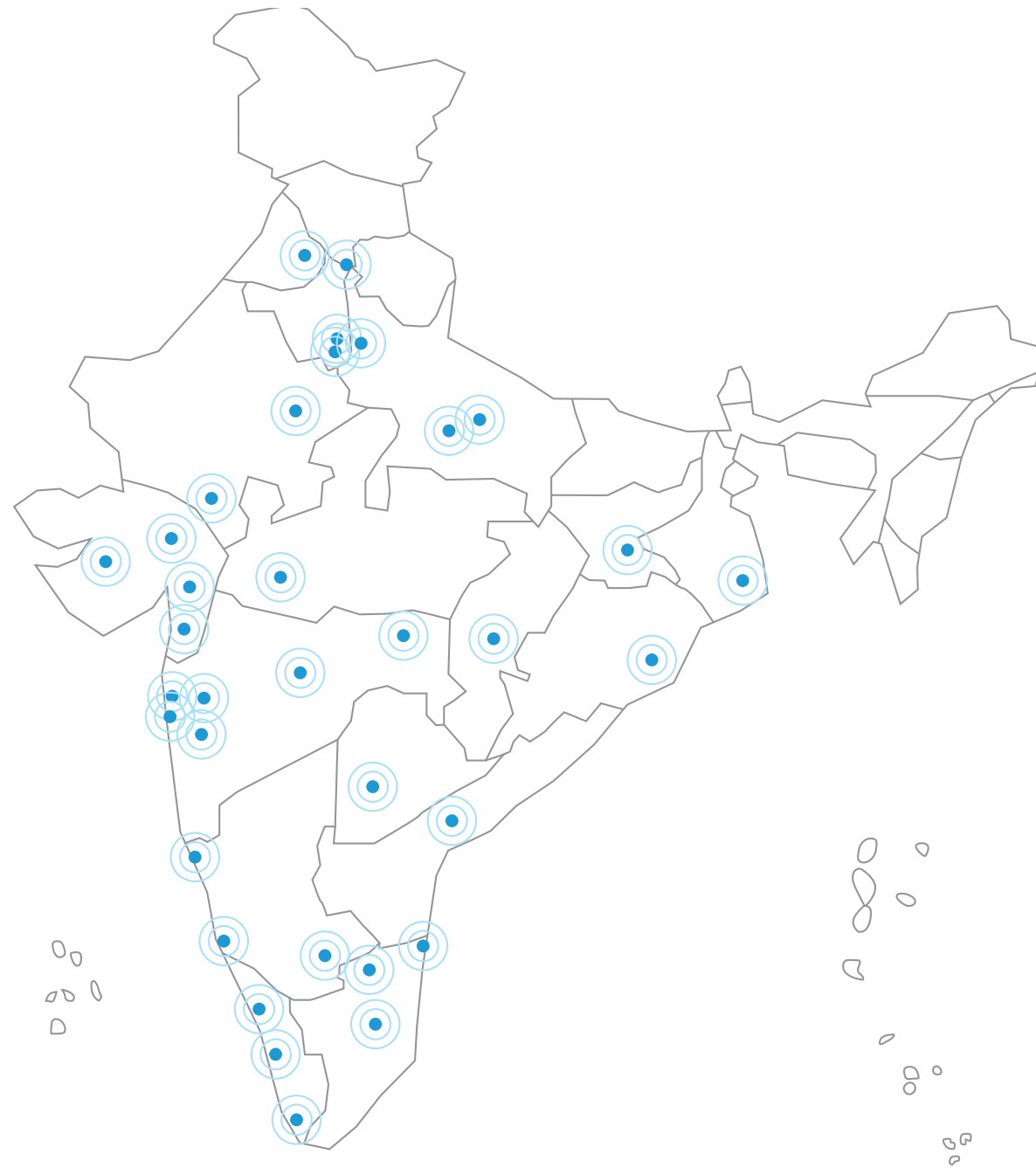

NORTH

BMW Bird Automotive

- SW 4IDC, MG Road, Gurugram
- S Golf Course Road, Sector 56 Gurugram

BMW Deutsche Motoren

- S Mohan Cooperative, Mathura Road New Delhi
- W Shivaji Marg, Moti Nagar, New Delhi
- SW Sector 27B, Mathura Road, Faridabad
- SW Sector 63, Noida

BMW Infinity Cars

- S Rajouri Garden, New Delhi
- W Mayapuri, New Delhi

BMW Krishna Automobiles

- SW Industrial Phase 1, Chandigarh
- SW GT Road, Ludhiana

BMW Sanghi Classic

- SW Tonk Road, Jaipur
- S Madri Industrial Area, Udaipur

BMW Speed Motorwagen

- SW Chinhat, Lucknow
- SW Kalpi Road, Kanpur

EAST

BMW OSL Prestige

- S Silver Arcade, Kolkata
- W East Topsia Road, Kolkata
- SW Bhanpur, Cuttack

BMW Titanium Autos

- SW Ormanjhi, Ranchi

WEST

BMW Bavaria Motors

- S Wellesley Road, Pune
- W Hadapsar, Pune
- SW Verna, Goa
- SW Chikalthana, Aurangabad

BMW Eminent Cars

- SW Surat-Dumas Road, Piplod, Surat
- SW Sunpharma Road, Vadodara

BMW Gallops Autohaus

- SW S G Highway, Sarkhej, Ahmedabad
- SW Gondal Road, Rajkot

BMW Infinity Cars

- S Worli, Mumbai
- S Nariman Point, Mumbai
- S Vashi, Navi Mumbai
- W Lalbaug, Mumbai
- W Worli, Mumbai
- W Turbhe, Navi Mumbai
- SW Dewas Naka, Indore

BMW Munich Motors

- SW Sarona, Raipur
- SW Hingna MIDC, Nagpur

BMW Navnit Motors

- S Juhu, Mumbai
- S Malad, Mumbai
- W Andheri, Mumbai
- W Gokul Nagar, Thane

SOUTH

BMW Deutsche Motoren

- S Whitefield, Bengaluru
- W Whitefield, Bengaluru

BMW EVM Autokraft

- SW Kalamassery, Kochi
- S Kovalam Road, Trivandrum
- W Kochuveli, Trivandrum

BMW KUN Exclusive

- S Khairtabad, Hyderabad
- S Jubilee Hill, Hyderabad
- W RTC, Cross Road, Hyderabad
- SW Mangalagiri, Vijayawada

BMW KUN Exclusive

- SW Meenambakkam, Chennai
- S EA Mall, Chennai
- S Ambattur, Chennai
- S OMR, Chennai
- W Ambattur, Chennai
- SW Avinashi Road, Coimbatore
- SW Virudhunagar, Madurai

BMW Navnit Motors

- S Lavelle Road, Bengaluru
- W Bethahalasoor Post, Bengaluru
- SW Hosur Road, Bengaluru

SW Showroom and Workshop S Showroom W Workshop

SEARCH



Scan to visit the BMW Online Shop

The pictorial representation does not purport to be the political map of India.



For more information, call 1800 102 2269.

The models, equipment and possible vehicle configurations illustrated in this brochure may differ from vehicles supplied in the Indian market. For precise information, please contact your local Authorised BMW Dealer. Subject to change in design and equipment. © BMW India Pvt. Ltd., Gurgaon, India. Not to be reproduced wholly or in part without written permission of BMW India Pvt. Ltd., Gurgaon, India.